

Operating instructions

Adora TS WP

Tumble dryer

Contents

1	Safety precautions	4			
1.1	General safety precautions	4	6.1	Cleaning the door filter and door filter mat .. 21	
1.2	Appliance-specific safety precautions	4	6.2	Cleaning the front filter mat (annually)	22
1.3	Instructions for use	6	6.3	Cleaning the moisture sensor	22
1.4	Using for the first time.....	7	6.4	Cleaning the temperature sensor	23
1.5	Note on the operating instructions	8	6.5	Cleaning the appliance.....	23
2	Appliance description	9	7	Trouble-shooting	23
2.1	Appliance construction	9	7.1	Error messages.....	23
2.2	Indicator lights	9	7.2	Other possible problems	24
2.3	Operating and display elements.....	10	8	Spare parts	26
3	Programme overview	11	9	Technical data	26
3.1	Automatic programmes	11	10	Drying tips	28
3.2	Standard programme.....	11	10.1	Saving energy	28
3.3	Additional programme	11	10.2	Avoiding damage	28
3.4	Fabric types	12	11	Disposal	29
3.5	Additional functions	13	12	Notes	30
3.6	EcoManagement.....	13		Quick instructions	32
4	Operating the appliance	14			
4.1	Preparations.....	14			
4.2	Selecting programme.....	14			
4.3	Selecting additional functions.....	15			
4.4	Delayed start.....	15			
4.5	Timed drying	15			
4.6	Changing selection.....	15			
4.7	Aborting a programme	16			
4.8	Interrupting a programme	16			
4.9	With childproof lock activated	16			
4.10	End of programme	17			
4.11	EcoManagement statistics	18			
5	User settings	18			
6	Care and maintenance	21			

1 Safety precautions

1.1 General safety precautions



- Read the operating instructions before using the appliance for the first time!



- This appliance can be used by children aged 8 and above and by persons with reduced physical, sensory or mental capabilities, or lack of experience and/or knowledge, provided they are supervised or have been instructed on the safe use of the appliance and have understood the hazards involved. Children shall not play with the appliance. Cleaning and user maintenance shall not be undertaken by children without supervision.
- If an appliance is not equipped with a mains cable and a plug or other means for disconnecting from the mains with a contact opening on each pole complying with the

conditions of overvoltage category III for full isolation, an isolating device must be incorporated into the permanently installed electrical installation in accordance with the installation regulations.

- If the mains cable of this appliance is damaged, it must be replaced by the manufacturer or its Customer Services or a similarly qualified person in order to avoid hazard.

1.2 Appliance-specific safety precautions



- Children under 3 years of age must be kept away from the appliance unless they are constantly supervised.
- The appliance has a maximum dry load capacity of 7 kg.
- This appliance is only suitable for drying textiles which have been washed in water.
- The appliance is only to be used with the recommended

vaporizing medium. The use of other substances may give rise to a toxic or fire risk.

- The appliance has hot surfaces to evaporate active components. These surfaces should not be touched during use.
- The tumble dryer may not be used if industrial chemicals were used for cleaning.
- Clean the fluff filters regularly.
- Do not allow fluff to build up around the tumble dryer.
- Do not dry unwashed items in the tumble dryer.
- Textiles that have been cleaned, treated or soaked with flammable chemicals, detergents or solvents (such as white spirit, alcohol, stain remover, oil, turpentine, acetone, paint, wax, etc.) are a fire and explosion hazard! Wash materials containing such substances first by hand with water or allow the solvent to evaporate completely.
- Items such as foam rubber (latex foam), shower caps, waterproof textiles, rubber backed articles and clothes or pillows fitted with foam rubber pads should not be dried in the tumble dryer.
- Fabric softeners, or similar products, should be used as specified by the fabric softener instructions.
- Remove objects such as lighters and matches and the like.
- Never stop a tumble dryer before the end of the drying cycle unless all items are quickly removed and spread out so that the heat is dissipated.
- If the appliance is installed on a carpeted floor ensure that any ventilation openings on the base of the appliance are not obstructed.
- If the appliance is installed in a housing, the ventilation openings are to be kept free of obstruction.
- Exhaust air must not be discharged into a flue which is used for exhausting fumes

from appliances burning gas or other fuels.

- Do not install the appliance behind a door that locks, a sliding door or a door with a hinge that lies opposite the hinge of the appliance.

To minimize the risk of fire in a tumble dryer, the following should be observed:

- Oil-affected items can ignite spontaneously, especially when exposed to heat sources such as in a tumble dryer. The items become warm, causing an oxidation reaction in the oil. Oxidation creates heat. If the heat cannot escape, the items can become hot enough to catch fire. Piling, stacking or storing oil-affected items can prevent heat from escaping and so create a fire hazard. If it is unavoidable that fabrics that contain vegetable or cooking oil or have been contaminated by hair care products be placed in a tumble dryer they should first be washed in hot water with extra detergent – this will reduce, but not elim-

inate, the hazard.

1.3 Instructions for use

Before using for the first time

- The appliance must be installed and connected to the electricity supply in accordance with the separate installation instructions. Have a qualified fitter/electrician carry out the necessary work.
- Ensure access to the place of disconnection (e.g. socket outlet, wall switch, fuse) and the water tap.

Correct use

- The appliance is only suitable for drying home textiles. It is designed for use in the home and for the above-mentioned purpose only. No liability is assumed for any damage caused by improper or incorrect use.
- Any repairs, modifications or manipulations to the appliance, especially any electrically live parts, may only be carried out by the manufacturer, its Customer Services or a similarly qualified person. Repairs if carried out incorrectly could cause serious injury or damage to the appliance and fittings as well as affect the functioning of the appliance. If the appliance is not working properly or in case of a repair order, follow the instructions given in the «Service & Support» section. If necessary, please contact our Customer Services.
- Use original spare parts only.
- Before closing the appliance door and starting a programme, ensure that there are no foreign objects or pets in the drum.

Note on use

- If the appliance is not operating properly, disconnect it from the power supply immediately.
- To protect your washing, follow the fabric care symbols and the hints and advice in the 'Drying tips' section.
- Do not operate the appliance without a door filter or with a damaged door filter. Fluff can destroy the appliance!

Caution: Burns hazard!

- Do not dry fabrics that contain traces of hair spray, hair gel, nail varnish remover or other similar substances. Danger of gas build-up!

Caution: Risk to life!

- Packaging material, e.g. plastic film and polystyrene, can be dangerous for children. Danger of suffocation! Keep packaging material away from children.

How to avoid damaging the appliance

- Transport the appliance in an upright position only! Transporting it in any other position will result in damage to the appliance! When carried carefully without being shaken, the appliance may be tilted a maximum of 90° to the left (viewed from the front).

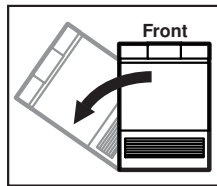

- Close the appliance door carefully.
- When cleaning the appliance make sure no water gets inside it. Use a moderately damp cloth. Do not spray the outside or the inside of the appliance with water. If water gets inside the appliance, it will cause damage.

1.4 Using for the first time



The appliance must be installed and connected to the electricity supply by a qualified fitter/electrician in accordance with the separate installation instructions.

Serial number

The serial number (FN) is located on the identification plate:

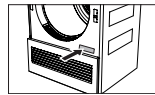

- ▶ Note down the FN on the back page of these operating instructions.

The FN can also be retrieved as follows:

- ▶ Hold the  button depressed until the following display appears:



User settings
FN XXXXX XXXXX

1.5 Note on the operating instructions

For more information on your appliance and for answers to frequently asked questions, visit <http://www.vzug.com>.

Symbols used



Denotes important safety precautions.



Caution, risk of fire!

Failure to observe said precautions can result in injury or in damage to the appliance or fittings!

Validity

The product family (model number) corresponds to the first alphanumeric on the identification plate. These operating instructions apply to:

Appliance designation	Adora TS WP
Type	WTATSWPZ
Product family	12005

Variations depending on the model are noted in the text.

Modifications

Text, diagrams and data correspond to the technical standard of the appliance at the time these operating instructions went to press. The right to make technical modifications for the purpose of the further development of the appliances is reserved.

2 Appliance description

2.1 Appliance construction

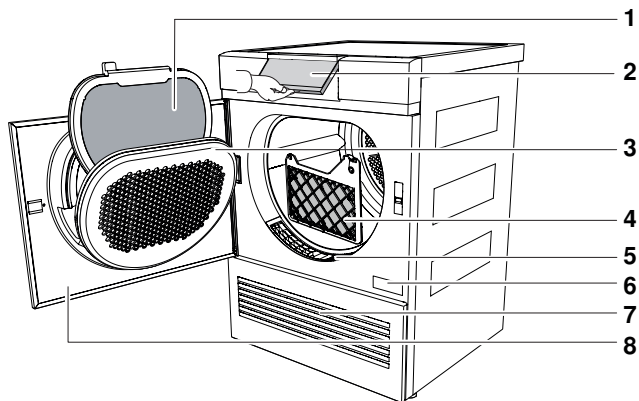

- | | | | |
|---|----------------------------------|---|---|
| 1 | Door filter with door filter mat | 5 | Front grille |
| 2 | Pivoting operating panel | 6 | Identification plate / serial number (FN) |
| 3 | Cover for door filter | 7 | Ventilation grille |
| 4 | Front filter mat | 8 | Appliance door |

2.2 Indicator lights



Illuminated: relevant function active



Off: relevant function not selectable

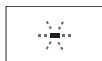

Flashing: relevant function selectable

2.3 Operating and display elements

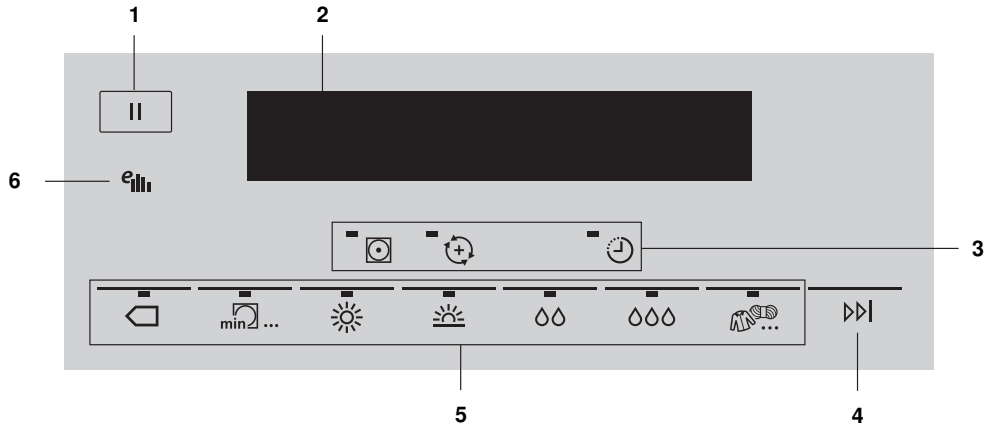

- | | | | |
|---|----------------------|---|----------------------|
| 1 | Pause | 4 | End of programme |
| 2 | Display | 5 | Automatic programmes |
| 3 | Additional functions | 6 | EcoManagement |

Additional functions

- Easy care
- ReversePlus
- Delayed start

Automatic programmes

- Extra dry
- Normal dry
- Iron dry
- Damp
- Fabric types
- Standard programme

Additional programme

- Timed drying

3 Programme overview

To avoid damaging the laundry, follow the fabric care symbols on garment labels:



Tumble dry, medium heat



Tumble dry, low heat



Do not tumble dry

3.1 Automatic programmes

Automatic drying programmes have 3 phases:

Drying	The laundry is dried according to the settings.
Cooling down / Final airing	The laundry is cooled down to a temperature at which creasing is minimized. The duration of this phase depends on the temperature of the laundry. «Crease guard» starts if the appliance is not unloaded when this phase ends.
Crease guard	The dried washing is moved at frequent intervals for up to 30 minutes to prevent creasing. Open the appliance door to end before time.



Extra dry: For thick, multi-layered textiles and mixed loads. Less suitable for knitted or woven articles (e.g. t-shirts or underwear). **1–7 kg**



Normal dry: For similar items of washing (e.g. t-shirts or underwear). **1–7 kg**



Iron dry: For items that are to be ironed. **1–7 kg**



Damp: For items that are to be pressed in a mangle (e.g. table linen). **1–7 kg**

3.2 Standard programme



The most efficient programme for drying normal wet cotton laundry. **1–7 kg**

3.3 Additional programme



Timed drying: For final drying of textiles. For final drying of sleeping bags and quilts, provided they have the relevant fabric care symbols. Load for bulky textiles: 1 item **1–7 kg**

3.4 Fabric types



► Press the button repeatedly to select the fabric type.

Airing: For refreshing or airing little-worn garments. **1–1.5 kg**

Woollens: Gentle drying for woollen textiles labelled as washable. **1 kg**

Silks: For drying silk fabrics. Follow the fabric care symbols as silk tends to crease easily. **1–1.5 kg**

Crease guard: For reduced creasing (e.g. shirts and blouses). The laundry is ready for ironing. **1 kg**

Shirts: Fabrics are gently dried to «cupboard dry». **1–7 items**

Outdoor garments: Leisure- and sportswear (Sympatex, Gore-tex, ...) are dried gently. **1–3 kg**

Denim: Denim fabrics are dried to «cupboard dry». Follow the fabric care symbols as denim material can shrink. **1–4 kg**

Baby garments: Baby garments are gently and hygienically dried to «cupboard dry». **1–5 kg**

Thin down filling: For light-weight down textiles (e.g. thin duvets and jackets). Optimum load: 1 item **1–2 kg**

Thick down filling: For bulky down textiles (e.g. pillows, jackets and thick duvets). If recommended, tennis balls can be used for fluffing up the down during drying. Optimum load: 1 item **1–2 kg**

Bedding: For similar items of washing. Fasten zips and buttons. **1–3 kg**

Towelling: For drying thick towels and terry towelling. **1–3 kg**

Basket programme: For drying clean canvas shoes/trainers and small items such as gloves, hats and soft toys in the basket (can be ordered as an accessory). Not suitable for leather or synthetic leather.

3.5 Additional functions



Easy care: Gentle drying for mixed fabrics (e.g. shirts, pullovers and T-shirts). The level of dryness is reduced. To prevent creasing, put only a few items of laundry in the washing drum and unload them as soon as the programme ends. **1–2.5 kg**



ReversePlus: The laundry is dried evenly and less likely to get tangled. Particularly suitable for drying larger items, e.g. bedding.



Delayed start: For taking advantage of cheap-rate electricity (setting range of up to 24 hours). The programme starts automatically when the delayed start set is reached.

3.6 EcoManagement



Only active if «EcoManagement» is turned on in the user settings.

EcoManagement provides information on the energy consumption of the appliance. The following statistical data can only be retrieved when no programme is running:

- Energy consumption of the last programme
- Total energy consumption
- Average energy consumption of the last 25 programmes

The energy consumption of a programme is displayed during programme selection. At the end of a programme, the energy consumption of the last programme run is displayed.

The values can vary according to programme, load, additional functions and user settings.

4 Operating the appliance

4.1 Preparations

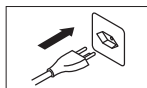

- ▶ Insert the mains plug into a suitable mains socket.



- ▶ Press the markings at the edge of the door (5 dots) and open the appliance door.



- ▶ Loosely load wet laundry items one by one into the appliance.



- ▶ Close the appliance door. Ensure that no items of laundry are trapped in the door.

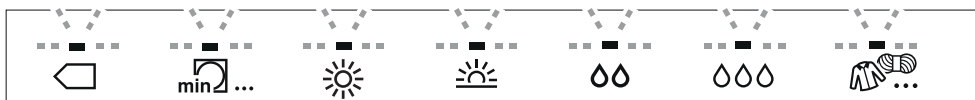

The indicator lights for the programme buttons flash. They go out after 20 seconds if no programme selection is made. A programme can still be selected afterwards.

4.2 Selecting programme

«Press and go»

When a programme is selected, all the necessary settings for it are assigned automatically. Additional functions can be selected or deselected by using further buttons in other views.



- ▶ Press the button for the desired programme.
The indicator lights for selectable additional functions flash.



If no button is pressed within the next 20 seconds, the programme selected starts automatically.

Duration remaining indicator

When the programme starts, the programme duration at maximum load is displayed. The letter «h» flashes for about 1 minute. During this time, the actual load is being determined and the expected duration remaining is being calculated.

Determining load 1h35

The expected duration remaining is subsequently displayed.

Drying	1h24
--------	------

The programme may possibly take longer than initially calculated. In this case, the duration remaining freezes while the programme runs. The letter «h» flashes again.

Calculating time remaining	0h15
----------------------------	------

4.3 Selecting additional functions



- ▶ Press the button for the desired programme.



- ▶ Press the button for the desired additional function.
If the programme needs to be changed, it is possible to select a new programme within 20 seconds. Additional functions must also be reselected.

If no button is pressed within the next 20 seconds, the programme selected starts automatically.

4.4 Delayed start



- ▶ Press the button for the desired programme.



- ▶ Press the button repeatedly until the time by which the start should be delayed (max. 24 hours) appears in the display.
The display goes dark. The programme starts when the set start time is reached.



- ▶ To reduce the remaining time delay in hourly intervals, press the button repeatedly again.
Laundry can be added at any time.

4.5 Timed drying



- ▶ Press button.
The set duration appears in the display.



- ▶ Press the button repeatedly until the desired duration is displayed.

4.6 Changing selection



- ▶ Press another programme button during programme selection.
All selected settings are cleared. No changes can be made once a programme has started. The programme must be aborted.

4.7 Aborting a programme



- ▶ Press button.
The programme is aborted. All settings are cleared.

4.8 Interrupting a programme

Through opening the appliance door



- ▶ Open the appliance door.
The indicator light for the programme selected illuminates. The programme is interrupted. Laundry can be added.



- ▶ Close the appliance door.
The indicator light for the programme selected flashes.

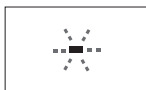

- ▶ Press the flashing programme button.
The programme is resumed.

Through pressing the pause button



- ▶ Press button.
The programme is interrupted.



- ▶ Press the button again.
The programme is resumed.

Note: Each time a programme is interrupted, the programme sequence is delayed by 5 minutes.

4.9 With childproof lock activated

How to turn the childproof lock on/off is described in «User settings».

Selecting programme



- ▶ Close the appliance door.
The following display appears:

Childproof lock

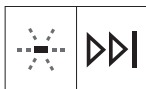

- ▶ Hold the desired, flashing programme button depressed and at the same time press the «End of programme» button.

After being unlocked, the appliance can be operated normally. The childproof lock is automatically activated as soon as the programme starts.

Interrupting a programme



- ▶ Open appliance door.
The programme is interrupted. Washing can be added.



- ▶ Close appliance door.

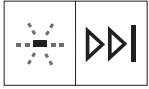

- ▶ Hold the flashing programme button depressed and at the same time press the «End of programme» button.
The programme continues.

Aborting a programme

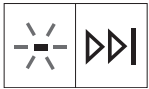

- ▶ With the appliance door open or closed, hold the illuminated programme button depressed and at the same time press the «End of programme» button.
The programme is aborted.

4.10 End of programme

Display

Depending on whether «EcoManagement» has been activated, information on the energy consumption is displayed when a programme ends.

With «EcoManagement»



The indicator light for the programme that has finished illuminates. The adjacent messages alternate in the display:

End of programme
Clean door filter

End of programme
⚡ 1.1kWh

Without «EcoManagement»



The indicator light for the programme that has finished illuminates. The adjacent display appears:

End of programme
Clean door filter

Note: Crease guard starts if the appliance is not unloaded straightaway. When it has finished, all displays go out.

Unloading the washing



- ▶ Open the appliance door.
All displays go out.



- ▶ Unload the laundry.

Note: If the appliance door is opened during the «Final airing» phase, the programme is aborted. All displays go out.

Each time after use

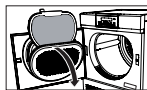

- ▶ Clean door filter (see page 21).



- ▶ Close appliance door.

4.11 EcoManagement statistics

Energy consumption can be displayed before a programme starts or after a programme ends.

Display total consumption



- ▶ Hold the button depressed for 3 seconds.
The adjacent display appears.

Total consumption
⚡ 123 kWh

Display average consumption



- ▶ Press the button again.
The adjacent display appears.

Average per cycle
⚡ 0.6kWh

5 User settings

Providing no programme is running and no error message is displayed, the user settings can be changed with the appliance door open or closed.

5.1 Preparations

The serial number has to be retrieved before the user settings can be changed.



User settings
FN XXXXX XXXXXX

- ▶ Hold the  button depressed until the adjacent display appears.
The user settings can be changed.

5.2 Language

1x



Language D/F/I/R/E
English

The language is set during the initial set-up of the appliance. It can be changed.

5.3 EcoManagement

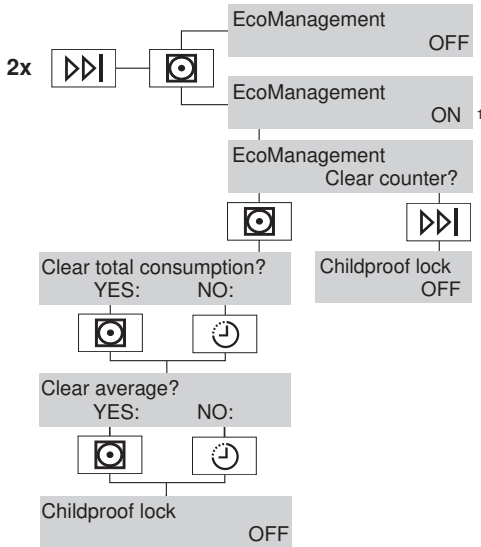

When this function is activated, expected consumption values appear at the start of the programme and actual consumption values appear at the end of the programme. The stored consumption values can be deleted as well.

5.4 Childproof lock

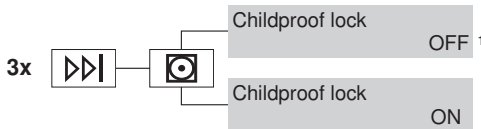

The childproof lock prevents a programme from being started accidentally. A programme can only be started by pressing two buttons at the same time.

5.5 Level of dryness

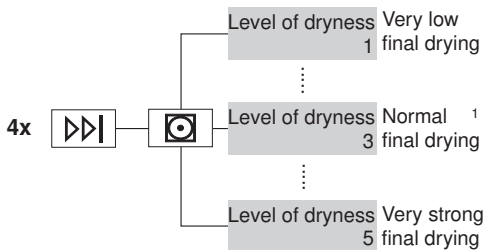

Change the level of dryness if the washing is not being dried sufficiently or is being overdried. The new level of dryness applies to all programmes. Very low final drying is recommended for very hard water and very strong final drying for very soft water. **Caution! Overdrying can weaken fabrics!**

5.6 ReversePlus

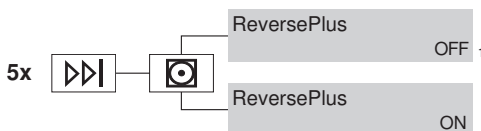

When this function is activated, the washing dries evenly and is less likely to get tangled.

¹ Factory setting

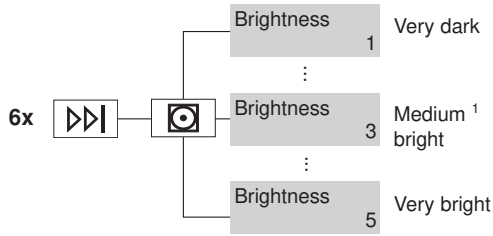

5.7 Brightness

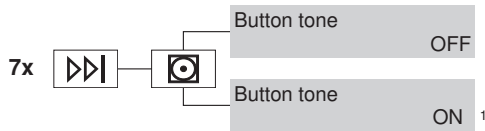

The display can be adjusted to the prevailing lighting conditions.

5.8 Button tone



The button tone can be turned on and off. The button tone for the  and  buttons cannot be turned off.

5.9 Factory settings

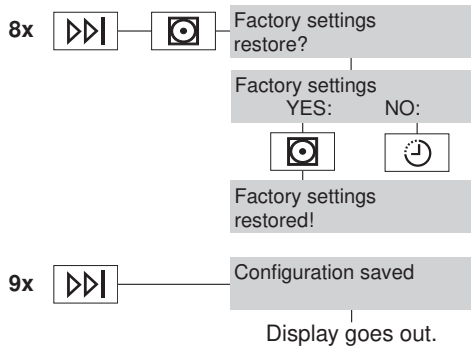

The factory settings can be restored. The language if changed is not reset to the factory setting.

¹ Factory setting

6 Care and maintenance



To minimize the risk of fire hazard regularly clean the filters!

A thick coating of fluff can trigger the «A9 Clean filter and mats» (see page 23) error message.

6.1 Cleaning the door filter and door filter mat

Cleaning the door filter (each time after tumble drying)

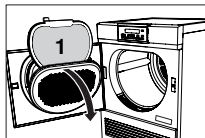

- ▶ Open appliance door and then open cover for door filter.
- ▶ Take out the door filter 1 and remove the fluff.
- ▶ Put back the door filter 1.
- ▶ Close cover for door filter and close appliance door.

Cleaning the door filter and door filter mat (as required)

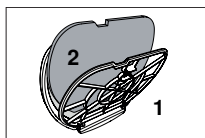

- ▶ Take out the door filter 1, as described in «Cleaning the door filter».
- ▶ Open the door filter 1 and take out the door filter mat 2.

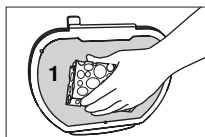

- ▶ Hold the door filter 1 up to the light to detect deposits. Clean the door filter 1 if necessary (with water, a sponge and abrasive liquid cleaning agent or cleaning vinegar).



- ▶ Wash the door filter mat 2 under running water or in a washing machine at 40 °C.
Caution! Never clean the door filter mat with a vacuum cleaner!

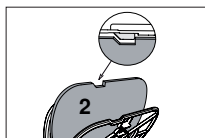
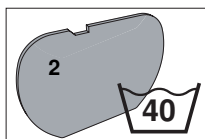

- ▶ Put the dry door filter mat 2 back into the door filter 1.
- ▶ Put back the door filter 1.
Note: Ensure the door filter 1 is positioned correctly.

6.2 Cleaning the front filter mat (annually)

If the «A9 Clean filter and mats» error message still appears after the door filter and the door filter mat have been cleaned, the front filter mat must also be carefully cleaned.

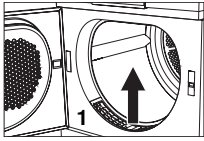

- ▶ Open the appliance door and remove the front grille **1**.

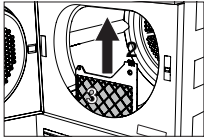

- ▶ Press the lug **2** down slightly to release and remove the front filter mat **3**.

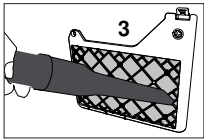

- ▶ Clean the front filter mat **3** carefully using a vacuum cleaner with the crevice tool attachment.
- ▶ Clean the air duct in front of the front filter mat with a vacuum cleaner or moist cloth if necessary.
- ▶ Put back the front filter mat **3** and engage. Ensure it is positioned correctly.
- ▶ Put back the front grille **1**.

Note: The appliance will not start without the front filter mat being correctly in place.

6.3 Cleaning the moisture sensor

If the «A3» error message appears, the moisture sensor must be cleaned.

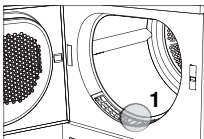

- ▶ Open appliance door.

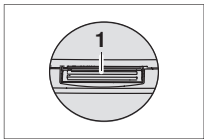

- ▶ Remove any fluff or foreign objects on the moisture sensor **1**.
- ▶ If necessary, clean moisture sensor **1** with a damp cloth and wipe dry.

6.4 Cleaning the temperature sensor

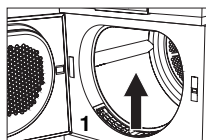

- ▶ Open the appliance door and remove the front grille 1.

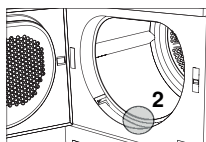

- ▶ Clean the temperature sensor 2 with a damp cloth.
- ▶ Put back the front grille 1.

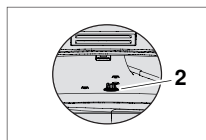

6.5 Cleaning the appliance

- ▶ Wipe the outside of the appliance from time to time with a damp cloth and wipe dry.

7 Trouble-shooting

You may be able to trouble-shoot the following errors yourself. If not, note down the error message in full (message, F and E numbers) and call Customer Services.







7.1 Error messages

Display	Possible cause	Solution
A0 Check outlet	<ul style="list-style-type: none"> ▪ The drain hose is blocked, kinked or defective. ▪ The pumping height of the drain hose is too high (>1.2 m). ▪ The appliance is connected to a concealed double drain trap. 	<ul style="list-style-type: none"> ▶ Check part of drain hose that is not housed in appliance. ▶ Press the ▶▶ button. ▶ Restart the programme.
A3 Clean moisture sensor	<ul style="list-style-type: none"> ▪ Moisture sensor is dirty or wet. 	<ul style="list-style-type: none"> ▶ Clean moisture sensor and then wipe dry (see page 22). ▶ Press the ▶▶ button. ▶ Restart the programme.

Display	Possible cause	Solution
A9 Clean filter and mats	<ul style="list-style-type: none"> ▪ Door filter, door filter mat or front filter mat are blocked. 	<ul style="list-style-type: none"> ▶ Check and clean (see page 21) parts. ▶ Press the ▶▶ button. ▶ Restart the programme.
Insert door filter / close appliance door	<ul style="list-style-type: none"> ▪ The door filter is missing. ▪ The appliance door is open. 	<ul style="list-style-type: none"> ▶ Insert door filter (ensure it is positioned correctly). ▶ Close the appliance door. ▶ Press the ▶▶ button. ▶ Restart the programme.
Insert front mat	<ul style="list-style-type: none"> ▪ The front filter mat is not inserted correctly. 	<ul style="list-style-type: none"> ▶ Insert front filter mat correctly. ▶ Press the ▶▶ button. ▶ Restart the programme.
FXX/EXX see instructions FN XXXXX XXXXXX	<ul style="list-style-type: none"> ▪ Various situations can lead to this error message. 	<ul style="list-style-type: none"> ▶ Press the ▶▶ button. ▶ Switch off the power supply for about 1 minute. ▶ Switch the power supply back on again and select a new programme.
	<ul style="list-style-type: none"> ▪ If the error appears again: 	<ul style="list-style-type: none"> ▶ Note down error message in full and appliance's FN. ▶ Switch off the power supply. ▶ Call Customer Services.
UXX/EXX see instructions FN XXXXX XXXXXX	<ul style="list-style-type: none"> ▪ Overvoltage (U1) ▪ Undervoltage (U2) 	<ul style="list-style-type: none"> ▶ Press the ▶▶ button. ▶ Switch off the power supply for about 1 minute. ▶ Switch the power supply back on again and select a new programme.
	<ul style="list-style-type: none"> ▪ If the error appears again: 	<ul style="list-style-type: none"> ▶ Disconnect from the power supply. ▶ Have an electrician check the house installation.

7.2 Other possible problems

Problem	Possible cause	Solution
The programme takes significantly longer than indicated.	<ul style="list-style-type: none"> ▪ Door filter and/or door filter mat are blocked. 	<ul style="list-style-type: none"> ▶ Clean (see page 21) door filter and/or door filter mat.
	<ul style="list-style-type: none"> ▪ Very wet washing. 	<ul style="list-style-type: none"> ▶ Spin washing at higher speed.
	<ul style="list-style-type: none"> ▪ The ambient temperature is too high or too low. 	<ul style="list-style-type: none"> ▶ Improve circulation and ventilation of air in room. ▶ Ensure that the temperature of the room is between 5 and 35 °C.

Problem	Possible cause	Solution
No new programme can be selected.	<ul style="list-style-type: none"> ▪ A programme was interrupted. 	<ul style="list-style-type: none"> ▶ Press the  button. ▶ Select a new programme.
The washing is not dry enough.	<ul style="list-style-type: none"> ▪ Mixed laundry load. 	<ul style="list-style-type: none"> ▶ Select a longer programme. ▶ Select the ... programme. ▶ Change (see page 19) the level of dryness.
	<ul style="list-style-type: none"> ▪ Interruption in power supply. 	<ul style="list-style-type: none"> ▶ Check the mains plug, lead and fuses.
	<ul style="list-style-type: none"> ▪ The moisture sensor is dirty. 	<ul style="list-style-type: none"> ▶ Clean (see page 22) the moisture sensor.
	<ul style="list-style-type: none"> ▪ The «demo mode» is activated. 	<ul style="list-style-type: none"> ▶ Open appliance door. ▶ Hold the  and  buttons depressed and at the same time press the  button. «Demo mode on/off» appears in the display and the  button flashes. ▶ Press the  button.
	<ul style="list-style-type: none"> ▪ Not yet reached level of dryness required. 	<ul style="list-style-type: none"> ▶ No action is necessary. The indicator will run automatically once the level of dryness is reached.
	<ul style="list-style-type: none"> ▪ Wash load very mixed. 	<ul style="list-style-type: none"> ▶ No action is necessary. The indicator will run automatically in a while.
The duration remaining indicator remains frozen for a longer period.	<ul style="list-style-type: none"> ▪ Build-up of fluff in door filter. 	<ul style="list-style-type: none"> ▶ Clean (see page 21) the door filter.
	<ul style="list-style-type: none"> ▪ The laundry is being cooled down. ▪ A high ambient temperature extends the cooling-down phase. 	<ul style="list-style-type: none"> ▶ No action is necessary. The laundry can be unloaded at any time as long as it is then spread out to cool down.
	<ul style="list-style-type: none"> ▪ The temperature sensor is dirty. 	<ul style="list-style-type: none"> ▶ Clean (see page 23) the temperature sensor.
	<ul style="list-style-type: none"> ▪ The appliance door is open. 	<ul style="list-style-type: none"> ▶ Close the appliance door.
The appliance will not start.	<ul style="list-style-type: none"> ▪ Door filter or front filter mat are missing. 	<ul style="list-style-type: none"> ▶ Insert door filter or front filter mat and ensure it is positioned correctly.
	<ul style="list-style-type: none"> ▪ Interruption in power supply. 	<ul style="list-style-type: none"> ▶ Insert plug into mains socket. ▶ Turn wall switch on.
		<ul style="list-style-type: none"> ▶ Check fuse or circuit breaker.

8 Spare parts

Please give model number and exact designation when ordering parts.

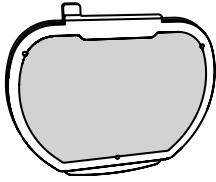

Door filter

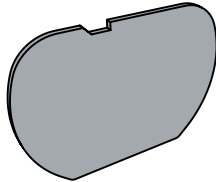

Door filter mat

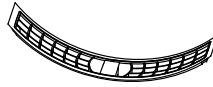

Front grille

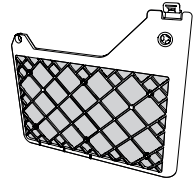

Front filter mat

9 Technical data

Dimensions

Height	85 cm
Width	59.5 cm
Depth	61 cm
Weight	65 kg
Pumping height of pump	1.2 m
Dry load capacity	7 kg

Ambient conditions

Permissible room temperature when appliance is in operation: 5 °C to 35 °C

Electrical connection

See identification plate:

- ▶ Open the appliance door. The identification plate is located bottom right.

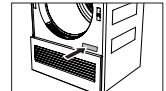

9.1 Note for testing institutes

- ▶ The appliance must be connected to the electricity supply for at least 5 minutes before taking measurements.
- ▶ The declaration data can be determined correctly only after a run-in phase of 5 complete drying programmes with washing (automatic programme: normal dry ).
- ▶ Wash the door filter each time after completing a drying programme.
- ▶ Set to the standard programme according to AS/NZS 2442.2:2000:

Programme

Load capacity

Standard programme

7 kg

- ▶ Press the  button.

Data for the standard programme

Load capacity	Programme duration	Energy star rating	Energy consumption
kg	hrs./mins.		kWh
7	2h42	9	1.66

9.2 Consumption values

The stated values for the programme duration and energy apply for the maximum stated capacity with a wash spun at around 1200 rpm (corresponds to a moisture level of around 60%). A higher spin speed or a smaller load reduce them by around 20–30%.

Automatic programmes

Programme	Load capacity	Residual moisture	Programme duration	Energy
	kg	%	hrs./mins.	kWh
Extra dry	1–7	-4 to -1	2h30	1.50
Normal dry	1–7	-1 to 2	2h03	1.23
Iron dry	1–7	8 to 16	1h40	0.98
Damp	1–7	20 to 30	1h20	0.74

Fabric types

Programme	Load capacity	Residual moisture	Programme duration	Energy
	kg	%	hrs./mins.	kWh
Airing	1–1.5	–	0h10	0.03
Silks	1–1.5	0 to 2	0h40	0.31
Crease guard	1	–	0h20	0.10
Shirts	1–7 items	0 to 2	0h35	0.27
Outdoor garments	1–3	0 to 2	1h05	0.59
Denim	1–4	-1 to 2	1h45	1.03
Baby garments	1–5	-1 to 1	2h10	1.24
Thin down filling	1–2	-1 to 1	2h00	1.20
Thick down filling	1–2	-1 to 1	2h40	1.50
Towelling	1–3	-1 to 1	1h25	0.82
Bedding	1–3	-1 to 1	1h30	0.81
Woollens	1	0 to 5	1h10	0.56

10 Drying tips

10.1 Saving energy

- Spin the washing in the washing machine at a high spin speed before tumble drying. Mechanical draining in the washing machine is much more efficient than water evaporation in the tumble dryer.
- Clean the door filter and the filter mats regularly. Dirty fluff filters block the air flow and reduce the appliance's efficiency.
- Where possible fill the drum to the maximum load capacity of the relevant programme.
- Select «EcoManagement» to find efficient programmes.

10.2 Avoiding damage

- Follow the fabric care symbols on garment labels.
- For drying, it is recommended that tumble dryer sheets or other fabric care solutions not be used.
- Remove foreign objects and larger parts made of metal or hard plastic (e.g. buckles, stones, detergent dosing aids) before tumble drying. These can dent the drum.
- Fasten hook and eye fasteners and zips. These can damage the laundry and the drum.
- Fasten cloth belts, apron ties and duvet and pillow cases to avoid them getting tangled up.

11 Disposal

11.1 Packaging



Never allow children to play with packaging material due to the danger of injury or suffocation. Store the packaging material in a safe location or dispose of it in an environmentally-friendly way.

11.2 Safety

Render the appliance unusable to prevent accidents caused by improper use (e.g. through children playing):

- ▶ Disconnect the appliance from the mains. With a fixed appliance, this is to be carried out by a qualified electrician. Then cut the mains cable off flush with the appliance.
- ▶ Remove or disable the lock on the appliance door.

11.3 Disposal



-  The «crossed out wheeled bin» symbol requires the separate collection of waste electrical and electronic equipment (WEEE). Such equipment can contain hazardous, environmentally harmful materials.
- These appliances are to be handed over to a designated collection point for the recycling of electrical and electronic equipment and must not be disposed of with unsorted household waste. And in this way, you will be helping to protect resources and the environment.
- For more information, please contact the local authorities.

11.4 Note on heat pump

This appliance is CFC-free. It contains fluorinated greenhouse gas covered by the Kyoto Protocol.

Heat pump	Hermetically closed
Greenhouse gas	R134a
Load capacity [kg]	0.370
GWP [(kg CO ₂)/(kg greenhouse gas)]	1430
Total GWP [t CO ₂]	0.529

12 Notes

Quick instructions

Please first read the safety precautions in the operating instructions!

To start programme:

- ▶ Open appliance door.
- ▶ Check door filter.
- ▶ Load laundry.
- ▶ Close the appliance door.

Services & support

Register your appliance today online via our website at www.vzug.com and benefit from the best possible support in the event of a malfunction – including during the manufacturer's 2-year warranty period. You will require the serial number (FN) and appliance designation to register your appliance. You will find them on the identification plate of your appliance.



You can make your own note of the FN and appliance designation or note them on the service sticker which comes with the appliance:

FN: _____

Appliance: _____

- ▶ Select programme and any additional functions (if required). Programme starts automatically after 20 seconds.

When programme has finished:

- ▶ When «Clean door filter» appears in the display, unload the dry laundry.
- ▶ Clean door filter.
- ▶ Close appliance door.

Your repair order

You can find the telephone number of the nearest V-ZUG service centre to you under www.vzug.com →Service →Service hotline.

General queries, accessories and service agreement

V-ZUG will be happy to help you with any general administrative or technical queries, to accept your orders for accessories and spare parts and to inform you about our progressive service agreements.



1013633-R04