



Operating instructions

VS 60 144

Vacuum drawer

Thank you for choosing to buy one of our products. Your appliance is made to high standards and is easy to use. Nevertheless, please take the time to read these operating instructions in order to familiarize yourself with the appliance and get the best use out of it.

Please follow the safety precautions.

Modifications

Text, diagrams and data correspond to the technical standard of the appliance at the time these operating instructions went to press. The right to make technical modifications for the purpose of the further development of the appliances is reserved.

Validity

The model number corresponds to the first alphanumeric on the identification plate. These operating instructions apply to:

| Model designation | Model number | Type | Size system |
|--------------------------|---------------------|--------------------------------|--------------------|
| Vacuum drawer 60 144 | 36001 | VS60144, VS60144g, VS60144c | 60-144 |
| Vacuum drawer 60 144 Vi | 36003 | VS60144Vi | 60-144 |

Variations depending on the model are noted in the text.

Contents

| | | | | | |
|----------|---|-----------|-----------|------------------------------------|-----------|
| 1 | Safety precautions | 4 | 9 | Trouble-shooting | 19 |
| 1.1 | Symbols used..... | 4 | 9.1 | What to do if | 19 |
| 1.2 | General safety precautions..... | 4 | 10 | Accessories and spare parts | 21 |
| 1.3 | Appliance-specific safety precautions | 4 | 11 | Technical data | 22 |
| 1.4 | Before using for the first time..... | 5 | 12 | Tips and tricks | 22 |
| 2 | General appliance description | 7 | 13 | Disposal | 23 |
| 2.1 | Using for the first time | 7 | 14 | Index | 24 |
| 2.2 | Construction | 7 | 15 | Notes | 25 |
| 2.3 | Operating and display elements..... | 8 | 16 | Service & Support | 27 |
| 2.4 | Explanation of the displays..... | 8 | | | |
| 3 | Opening and closing the drawer | 8 | | | |
| 4 | Operating the appliance | 9 | | | |
| 5 | Food handling | 10 | | | |
| 5.1 | Quality and hygiene | 10 | | | |
| 5.2 | Preparing special types of food..... | 11 | | | |
| 5.3 | Storage | 11 | | | |
| 5.4 | Vacuisine © | 11 | | | |
| 6 | Vacuum sealing food | 12 | | | |
| 6.1 | Food | 12 | | | |
| 6.2 | Recommended vacuuming levels..... | 12 | | | |
| 6.3 | Selecting the level for sealing time | 14 | | | |
| 7 | Overview of applications | 14 | | | |
| 7.1 | Vacuuming and sealing..... | 14 | | | |
| 7.2 | Vacuuming only | 14 | | | |
| 7.3 | Sealing only | 14 | | | |
| 7.4 | External vacuuming* | 15 | | | |
| 8 | Care and maintenance | 16 | | | |
| 8.1 | General notes..... | 16 | | | |
| 8.2 | Cleaning | 16 | | | |
| 8.3 | Replacing the sealing bar..... | 17 | | | |
| 8.4 | Replacing the appliance lid gasket..... | 17 | | | |
| 8.5 | Replacing the seal pad | 18 | | | |
| 8.6 | System check..... | 18 | | | |
| 8.7 | Dehumidifying..... | 18 | | | |

1 Safety precautions

1.1 Symbols used



Denotes important safety precautions.

Failure to observe said precautions can result in injury or in damage to the appliance or fittings!



Information and precautions that should be observed.



Information on disposal



Information about the Operating Instructions

- ▶ Indicates step-by-step instructions.
 - Describes how the appliance reacts to the steps taken.
- Indicates a list.

1.2 General safety precautions



- Read the operating instructions before using the appliance for the first time!



- This appliance can be used by children aged 8 and above and by persons with reduced physical, sensory or mental capabilities, or lack of experience and/or knowledge, provided they are supervised or have been instructed on the safe use of the appliance and have understood the hazards involved. Children shall not play with the appliance.

Cleaning and user maintenance shall not be undertaken by children without supervision.

- If an appliance is not equipped with a mains cable and a plug or other means for disconnecting from the mains with a contact opening on each pole complying with the conditions of overvoltage category III for full isolation, an isolating device must be incorporated into the permanently installed electrical installation in accordance with the installation regulations.
- If the mains cable of this appliance is damaged, it must be replaced by the manufacturer or its Customer Services or a similarly qualified person in order to avoid hazard.

1.3 Appliance-specific safety precautions



The sealing bar gets hot during use. Care should be taken. Avoid touching the sealing bar. Burns hazard. Other accessible parts can get hot during use. Keep young children away from the appliance.

- Do not use aggressive or abrasive detergent or sharp metal scrapers for cleaning the glass lid of the appliance

as they could scratch the surface. This could result in damage to or destruction of the glass.

- Never use a high-pressure or steam cleaner for cleaning the appliance. Risk of short circuiting!
- Use the vacuum bags recommended for this appliance! Using non-original bags may damage the sealing bar.
- For external vacuuming of glass bottles, only use bottles that are suitable for vacuuming. Bottles that are unsuitable or already damaged could implode during external vacuuming and cause injury.
- Any repairs, modifications or manipulations to the appliance, especially any electrically live parts, may only be carried out by the manufacturer, its Customer Services department or similarly qualified persons. Repairs if carried out incorrectly may cause serious injury, damage to the appliance and fittings, as well as affect the functioning of the appliance. If the appliance is not working properly or in case a repair is needed, follow the instructions given in the 'Service & Support' section. Contact our Customer Services if necessary.
- Use original spare parts only.
- Retain these operating instructions for future reference. If you sell the appliance or pass it on to a third party, please ensure these operating instructions accompany the appliance, together with the installation instructions. In this way, the new owners can inform themselves about how to use the appliance correctly and read the pertinent safety precautions.

1.4 Before using for the first time

- The appliance must be installed and connected to the electricity supply in accordance with the separate installation instructions. The necessary work must be carried out by a qualified fitter/ electrician.

Correct use

- The appliance is designed for use in the home for preparing food. No liability is assumed for any damage caused by improper use or incorrect handling.
- The appliance should only be installed and operated in a room with an ambient temperature of between 5 °C and 35 °C.

Children in the home

- The appliance is designed for use by adults who are familiar with these operating instructions. Children may not always be aware of the danger involved in using electrical appliances. Ensure proper supervision and do not allow children to play with the appliance – there is a danger that children could hurt themselves.

Note on use

- If the appliance is visibly damaged, do not use it. Call Customer Services.
- If the appliance is not functioning properly, disconnect it from the power supply immediately.
- Ensure the mains cables of other electrical appliances do not get trapped in the appliance. The electrical cable insulation could become damaged.
- If the mains cable of the appliance is damaged, it must be replaced by our Customer Services in order to avoid hazard.
- Ensure there are no foreign bodies or pets in the vacuum drawer before closing it.
- Objects that could pose a danger if the appliance were accidentally switched on must not be stored in the vacuum drawer. This includes in particular containers with gas or air chambers (e.g. spray cans).
- Repairs if carried out incorrectly may cause a safety hazard. Risk of electric shock! Only a technician from our Customer Services may carry out repairs.

Caution: Burns hazard

- The sealing bar on the appliance gets very hot. The sealing seam of the vacuum bag also heats up strongly during the sealing process.

Caution: Risk of injury

- Do not sit or lean on the appliance or use it as a storage surface.
- Made from glass, the appliance lid is under tension. Damage to the surface of the glass may cause it to shatter. The appliance must not be operated if the lid is cracked or broken. Contact Customer Services.

Caution: Risk to life

- Danger of suffocation! Keep packaging material, e.g. plastic film and polystyrene, away from children and animals. Packaging material can be dangerous for children and animals.

How to avoid damaging the appliance

- Open and close the appliance lid slowly.
- Do not put any objects on the appliance, especially any sources of heat or cold. Do not drop any objects on the appliance lid.
- Only chilled food should be vacuum sealed.
- A maximum of 40 vacuum and sealing processes can be carried out one after the other.
- When vacuuming or cleaning make sure no water gets inside the appliance and in particular into the suction inlet of the vacuum pump. Use a moderately damp cloth for cleaning. Do not spray the outside or the inside of the appliance with water. If water gets inside the appliance, it will cause damage.
- Take care not to damage the lid gasket with pointed or sharp objects. Do not use any cleaning agent to clean the lid gasket – use just a damp cloth.

2 General appliance description

Food can be vacuum sealed in bags in the vacuum drawer. The vacuum-packed food can be cooked gently in a steam cooker (Vacuisine) or in a water bath. Vacuum-packing can prolong the shelf life of certain foodstuffs.

2.1 Using for the first time

Before operating the newly installed appliance for the first time, the following steps should be taken:

- Remove packaging and transport materials from out of the vacuum tank.
- Remove the operating instructions, bags and any unneeded accessories.

2.2 Construction

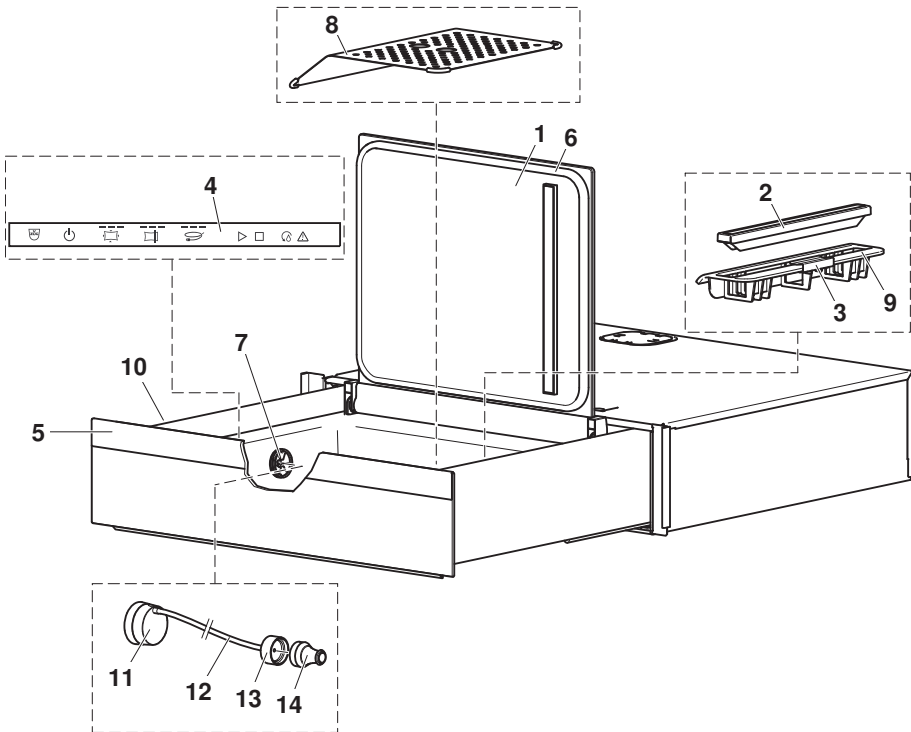

- | | | | |
|---|--|----|-----------------------------|
| 1 | Appliance lid made from glass | 8 | Bag tray |
| 2 | Sealing bar | 9 | Cover for sealing bar |
| 3 | Bag clip | 10 | Identification plate |
| 4 | Operating and display elements | 11 | Suction inlet adapter* |
| 5 | Drawer front (push-and-pull opening and closing mechanism) | 12 | Tube* |
| 6 | Appliance lid gasket | 13 | Adapter for vacuum stopper* |
| 7 | Suction inlet | 14 | Vacuum stopper* |

* Depending on the software version

2.3 Operating and display elements

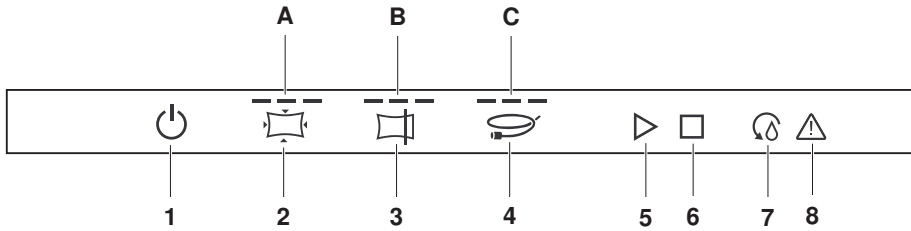

| Displays | | Buttons | |
|----------|---------------------------------------|---------|---------------------|
| A | Vacuuming level | 1 | On/Off |
| B | Sealing time | 2 | Vacuuming level |
| C | Vacuuming level – external vacuuming* | 3 | Sealing time |
| | | 4 | External vacuuming* |
| | | 5 | Start |
| | | 6 | Stop |
| | | 7 | Dehumidifying |
| | | 8 | Maintenance |

* Depending on the software version

2.4 Explanation of the displays

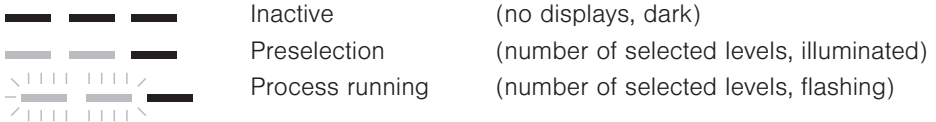

3 Opening and closing the drawer

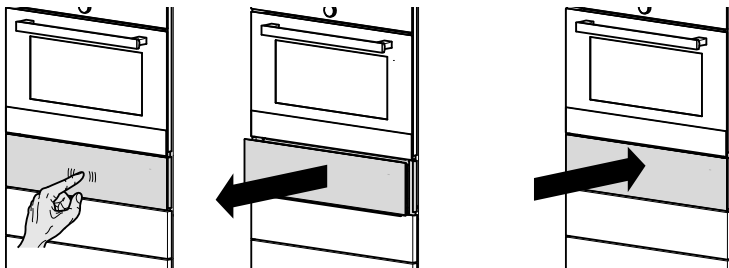

Opening

- ▶ Push in the middle of the drawer front.
 - The drawer opens.



Never force the drawer open

as this could damage the closing mechanism (push/pull system).

Closing

- ▶ Close in the middle of the drawer front.
 - The drawer engages and closes.

4 Operating the appliance

Switching on

- ▶ Touch the  button.
 - The appliance is ready for operation.
- ▶ Open the appliance lid.

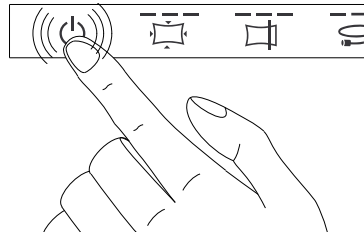
**Inserting bag**

- ▶ Put the food into the vacuum bag.
 - ▶ Push the opening of the bag under the bag clip 1.
-
- ▶ Use the bag tray 2 supplied for smaller amounts of food.

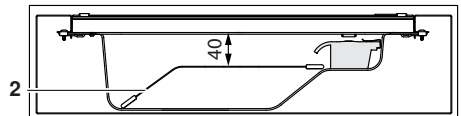
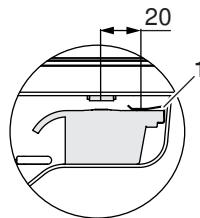
**Settings**

- ▶ Select the vacuuming level with the  button and the sealing time with the  button.

Starting the process

- ▶ Close the appliance lid.



**There must be plenty of room in the vacuum tank for the bag with food.
The appliance lid must close easily without any resistance.**



The gasket and the contact surface of the gasket must be clean and free of objects. The bag must lie completely flat on the sealing bar, without any overlap or wrinkles.

- ▶ Push the appliance lid shut and touch the  button to start the process.
 - The displays for the level of vacuuming and sealing time flash during the vacuuming process.

End of operation

- An acoustic signal is emitted when the process is finished.
- ▶ Open the appliance lid and remove the vacuum-sealed product.

Aborting or switching off before time

Touch the  or  button to interrupt the vacuuming process while it is running. The bag is not sealed. The end of the vacuuming process (ventilation running) cannot be interrupted.

Switching the appliance off

- ▶ Touch the  button.
 - The appliance switches off.

Sealing sooner

The vacuuming process can be interrupted and the bag sealed sooner.

- ▶ Touch the  sealing time button.



Liquids already start to boil at low temperatures when under a vacuum. This produces steam, which can cause the appliance to malfunction. Carefully watch the vacuuming process and seal the bag sooner if bubbles start to form (boiling).

5 Food handling

Vacuum sealing food can generally extend its shelf life.

5.1 Quality and hygiene



**The bacterial content of food determines how long a product can be preserved.
The higher the bacterial content, the shorter the maximum storage time.**

In order to preserve food for as long as possible, only vacuum seal food that is in perfect condition. Products that have been kept for some time before vacuum sealing have a higher bacterial content and are therefore not suitable for long-term storage.

To prevent fresh food from being contaminated with bacteria, the following points should be observed:

- Wash hands well before handling food.
- Ensure food preparation surfaces are smooth and hygienically clean. Clean food preparation surfaces before use.
- Clean all utensils (knives, forks, spoons, etc.) before use.

5.2 Preparing special types of food

Some types of food have to be specially prepared so that they can be stored.

Brassicas, pulses, stalks and shoots

All brassicas (cauliflower, broccoli, white cabbage, red cabbage, etc.), pulses (fresh beans, peas, etc.), and stalks and shoots (asparagus, etc.) release gas when vacuum sealed. These foods have therefore to be blanched in a steam cooker or in plenty of boiling water, then run under cold water until cold. The vacuum-sealed food can then be frozen (as it is compact it takes little space in the freezer).

Only a few varieties of vegetables, e.g. carrots, leeks, sweet peppers, bunching onions, Chinese cabbage, Pascal celery, tomatoes (for cooking) and herbs, can be frozen in their raw state. Portion the prepared and chopped vegetables in freezer bags and deep-freeze. For making your next Swiss barley soup or minestrone, ideally dice, vacuum seal and deep-freeze the raw vegetables.

5.3 Storage

To store food safely, the following points must be observed:

- Food that is to be stored must be fresh and in perfect condition.
- The product must be already at the storage temperature before vacuum sealing.
- Keep any interruptions to the cool chain as short as possible.
- Where possible, dry the food before vacuum sealing.
- Avoid mixing raw and cooked foods.
- Select the highest level of vacuuming possible, as given in the section: Recommended vacuuming levels (see page 12).
- Large pieces of food can be preserved for longer than smaller pieces.
- Store food at as low a temperature as possible.
- Place the food in the refrigerator or freezer immediately after evacuating the air.
- Perishables should always be kept in a refrigerator or freezer, even when vacuum-packed. Vacuum sealing food is not the same as preserving it!

5.4 Vacuisine ©

Vacuum-sealed food can be prepared using the sous-vide method of cooking. At V-ZUG, we call this method Vacuisine.



Only use original V-ZUG vacuum bags for the Vacuisine method.

For detailed information and Vacuisine recipes, go to vzug.com.

6 Vacuum sealing food

6.1 Food

Several points have to be considered when vacuum sealing food and preparing for sous-vide cooking.

Choice of bag

For sous-vide cooking, use original V-ZUG vacuum bags only. These vacuum bags are suitable for use between a temperature range of -40 °C to +115 °C and thus also for sous-vide cooking. The vacuum bags are microwave-safe (e.g. for defrosting frozen food). A bag containing food that has been sealed under vacuum must be pierced or opened before microwaving. Overpressure can otherwise develop and cause the vacuum bag to burst.

If bags other than V-ZUG vacuum bags are used for sous-vide cooking, these could become soft, the sealing seam may not hold or may melt. Only use other bags for vacuum sealing and adjust the sealing time to the material of the bag.



Using non-original bags may damage the sealing bar. The use of such bags is at the owner's own risk.

Size of bag

Select size of bag so that the food to be vacuum sealed fills max. two-thirds of the volume of the bag.

Food

For optimal results, the food must be chilled before vacuum sealing.

Refrigerate the food at a maximum of 5 °C for at least two hours before vacuum sealing.

Liquid foodstuffs, in particular, should not be warmer than 10 °C.



Never vacuum seal warm or hot food.





Filling the vacuum bag

When filling the bag make sure the area where the bag is to be sealed remains clean, otherwise the bag may not seal properly. Fold the top of the bag down (inside facing out) about 5 cm before filling it.

6.2 Recommended vacuuming levels

Selecting the vacuuming level

The following vacuuming levels are available for selection (after portioning) for packaging, marinating, sous-vide cooking (Vacuisine ©), freezing or storing:

| Vacuuming level with display | Food category with examples | Tips and uses |
|---|--|--|
| 0 (sealing)  | <ul style="list-style-type: none"> ▪ Very fragile and delicate food, e.g. crisps and salad. | <p>For very fragile and delicate foods that are originally packed with an air cushion, the original or vacuum bag should not be filled more than a third full. Loosely place the bag with the air cushion in the vacuum drawer so that the form and consistency of the food remains intact.</p> |
| 1  | <ul style="list-style-type: none"> ▪ Fragile and delicate fruit, e.g. berries, plums, apricots, bananas. ▪ Liquids and solids with a lot of liquid, e.g. soups, sauces and meat with a lot of marinade. ▪ Jars and bottles, e.g. jars of nuts, seeds and kernels, opened jars of pesto. | <p>With vacuuming level 1, fragile and delicate fruit keeps its shape and consistency and is not deformed.</p> <p>Vacuum pure liquids or meat with a lot of vinegar- or wine-based marinade on vacuuming level 1 only. The vacuum is sufficient for reduced oxidation of wine and vinegar.</p> <p>Opened jars of pesto can be sealed airtight again using vacuuming level 1, provided they are not too tall. Nuts, seeds and kernels can be similarly vacuum-packed to protect against infestation.</p> <p>Air and hence also oxygen is evacuated out of bottles of oil and wine ideally using external vacuuming level 1.</p> |
| 2  | <ul style="list-style-type: none"> ▪ Firmer fruit, e.g. pears and quinces. ▪ Less firm vegetables such as sweet peppers, tomatoes and courgettes. ▪ Fish, whole unskinned or filleted. ▪ Solids with a little liquid, e.g. meat with a little marinade. | <ul style="list-style-type: none"> ▪ Firmer fruit and solids with a little liquid can be vacuum sealed using vacuuming level 2. ▪ Vegetables and fish with a little or no liquid can be vacuum sealed ideally using vacuuming level 2. ▪ Meat in a sauce or with a little marinade is also suitable for vacuum sealing on vacuuming level 2. If there is a lot of liquid, use vacuuming level 1. |
| 3  | <ul style="list-style-type: none"> ▪ Meat, e.g. medallions, steak. ▪ Firm vegetables, e.g. carrots, beetroot. ▪ Food for freezing ▪ Hard cheese for storing | <ul style="list-style-type: none"> ▪ Meat without any added liquid, e.g. just with herbs, and firmer vegetables can be prepared, e.g. for sous-vide cooking (Vacuisine ©), ideally using vacuuming level 3. Vacuuming level 3 should be used for food that is going to be frozen as extracting the air prevents freezer burn. |

6.3 Selecting the level for sealing time

If using original V-ZUG vacuum bags, set the sealing time to level 2.

If using non-original bags, the sealing time must be adjusted to the material of the bag.



Using non-original bags may damage the sealing bar. The use of such bags is at the owner's own risk.

7 Overview of applications



All possible applications are described below.

See also the advice in the Tips and tricks (see page 22) section.

7.1 Vacuuming and sealing

This is the standard application of the vacuum drawer. The process starts and an underpressure is created inside the vacuum tank. The opening of the bag placed inside it is sealed. Then the pressure in the appliance is equalized again and the process is finished.

The vacuum drawer must be ready for operation.

- ▶ Touch the  button once or more to select a suitable vacuuming level.
- ▶ Touch the  button once or more to select a suitable level for the sealing time.
- ▶ Press down the appliance lid and start the process with the  button.



More detailed information on vacuuming and sealing can be found in the Operating the appliance (see page 9) section.

7.2 Vacuuming only

Jars with screw-top lids, containing e.g. nuts or kernels, can be vacuumed and sealed airtight at the same time using this application.





Only use jars with intact screw-top lids. Check that the jars are not too tall before closing the appliance lid.

Do not use the bag tray.

The jars may be max. 8.5 cm tall to avoid damage to the appliance.

This application is not suitable for making jam (filling with hot content). Only chilled food should be vacuum sealed.

The vacuum drawer must be ready for operation.

- ▶ Lightly close the screw-top lids of the jars and place the jars in the vacuum tank.
- ▶ Touch the  button once or more to select a suitable vacuuming level.
- ▶ Touch the  button repeatedly until the display for the sealing time goes out completely.
- ▶ Press down the appliance lid and start the process with the  button.



7.3 Sealing only

Using this application, a bag can be closed airtight without creating a vacuum.



Despite the setting, a slight underpressure is created in the bag, and this is necessary to create a successful seal.

The vacuum drawer must be ready for operation.

- ▶ Touch the  button repeatedly until the display for the vacuuming level goes out completely.
- ▶ Touch the  button once or more to select a suitable level for the sealing time.
- ▶ Press down the appliance lid and start the process with the  button.

7.4 External vacuuming*

* Depending on the software version

Using this application, air can be evacuated out of glass bottles of oil and wine, for instance, to prevent the contents reacting with the oxygen. This function can also be used to vacuum seal commercially available vacuum containers. Make sure that the vacuum containers are safe for use with food and can be connected to the vacuum drawer tube, which has a 3 mm internal diameter, using a suitable adapter.

 **For external vacuuming of glass bottles, only use bottles that are suitable for vacuum sealing. Unsuitable or damaged bottles could implode during external vacuuming. There is a risk of injury.**

The vacuum drawer must be ready for operation and the lid open.

- ▶ To evacuate a bottle, push either end of the tube onto the right connector for each adapter.
- ▶ Put the larger adapter on the suction inlet in the vacuum tank. To evacuate a bottle, put the smaller adapter with the other end of the tube on the vacuum stopper, which is pressed into the bottle mouth. To evacuate a vacuum container, connect the end of the tube to the vacuum container – rather than to the bottle – using an adapter if necessary.

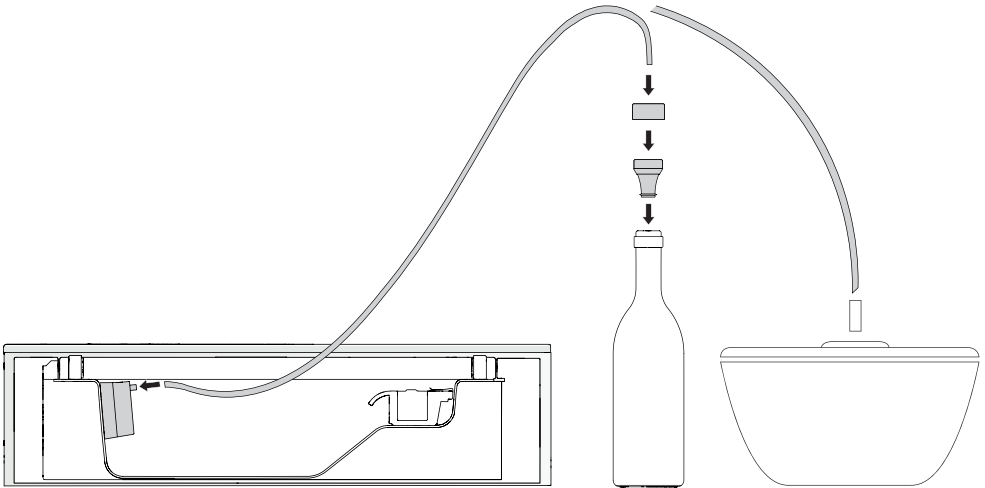

 Place the bottle for external evacuating on a flat and stable surface near the vacuum drawer.

- ▶ Touch the  button once or more to select a suitable vacuuming level. See "Recommended vacuuming levels (see page 12)".

 Vacuum seal large quantities of liquid in solid containers with an appropriate volume.



To evacuate wine bottles, only use external vacuuming on level 1 as otherwise the gas in the wine will be affected.

- ▶ Start external vacuuming with the ▷ button.

8 Care and maintenance

8.1 General notes



**The drawer must be switched off for cleaning.
Incorrect handling can result in damage to the appliance!**

- Do not use any abrasive cleaning agents, metal scrapers that are sharp or scratch, steel wool, abrasive scouring pads, etc. to clean the appliance, as they will damage the surface. Scratches to the glass lid can cause it to crack.
- Never use a high-pressure or steam cleaner to clean the appliance.
- Ensure no liquids or solids get into the suction inlet of the vacuum pump. This would cause irreparable damage to the pump.

8.2 Cleaning

Outside

- ▶ Remove any soiling or excess cleaning agent immediately.
- ▶ Clean the surfaces with a soft cloth dampened with water and a little washing-up liquid – for metallic surfaces rub in the direction of the original polish lines.
- ▶ Dry with a soft cloth.

Inside

- ▶ Remove the sealing bar **1** incl. sealing bar cover **2** from the appliance.
- ▶ Remove any soiling or excess cleaning agent immediately.
- ▶ Clean the surfaces with a soft cloth dampened with water and a little washing-up liquid – for metallic surfaces rub in the direction of the original polish lines.
- ▶ Dry with a soft cloth.
- ▶ Clean the sealing bar **1** with a soft cloth dampened with water and a little washing-up liquid and dry with a soft cloth. The sealing bar cover **2** can be cleaned in the dishwasher.
- ▶ Put the sealing bar cover **2** back in place in the appliance.
- ▶ Position the sealing bar **1** on the two locating pins in the appliance.

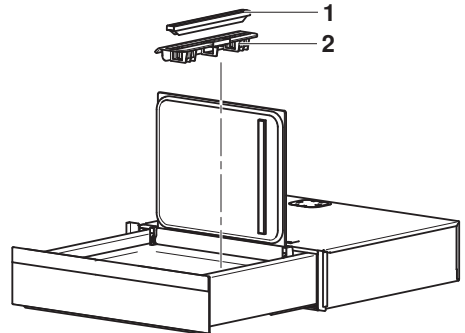

Appliance lid gasket

- ▶ Clean the appliance lid gasket with a soft cloth dampened with water.



Do not use detergent!

- ▶ Dry with a soft cloth.

Parts used in external vacuuming

Clean the parts used in external vacuuming (suction inlet adapter, tube, adapter for vacuum stopper and vacuum stopper) with hot water, a little washing-up liquid and a soft cloth or sponge and then wipe dry.

Accessories

The bag tray can be cleaned in the dishwasher.

8.3 Replacing the sealing bar

- ▶ Remove the damaged sealing bar **1** together with the sealing bar cover **2** from the appliance.
- ▶ Put the sealing bar cover **2** back in place in the appliance.
- ▶ Position the new sealing bar **1** on the two locating pins in the appliance.

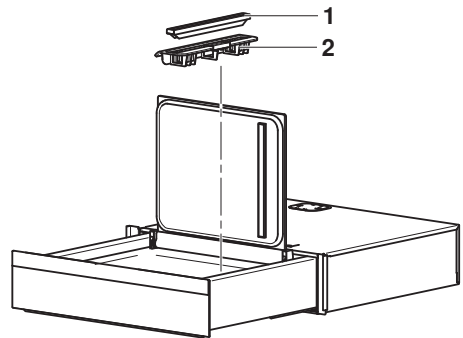

No aids or tools are needed.

8.4 Replacing the appliance lid gasket

- ▶ Remove the damaged appliance lid gasket **3**.
- ▶ Fit the new appliance lid gasket.

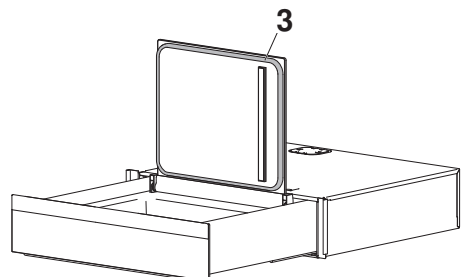

No aids or tools are needed.

8.5 Replacing the seal pad

The seal pad **4** is located on the underside of the appliance lid.

- ▶ Take the damaged seal pad **4** out of its holder **5**.
- ▶ Insert the new seal pad **4** in the holder **5**.

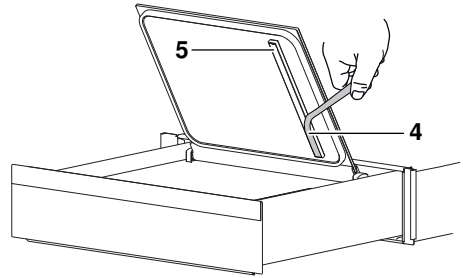

No aids or tools are needed.

8.6 System check



If the maintenance button \triangle illuminates, the vacuum pump cannot achieve the required underpressure in the allotted time. The appliance lid may not be closed properly or the appliance lid gasket may be dirty or damaged.

- ▶ Cleaning the lid gasket (see page 16). Do not use detergent!
- ▶ Close the appliance lid and press down.

If after the next vacuuming process the maintenance button \triangle remains illuminated:

- ▶ Select a lower vacuuming level.

If the maintenance button \triangle repeatedly illuminates:

- ▶ Wait until the Ⓞ symbol illuminates.
- ▶ Dehumidify the vacuum pump (see page 18).

8.7 Dehumidifying



Dehumidification is necessary when the oil in the vacuum pump contains too much water (from frequently vacuuming moist foodstuffs).

If the Ⓞ and \triangleright buttons illuminate, ...

... the oil in the vacuum pump can be dehumidified.

- ▶ Close the appliance lid and press down.
- ▶ Touch the Ⓞ button.
 - The oil in the vacuum pump is being dehumidified.



If the Ⓞ and \triangle buttons illuminate, ...

... the oil in the vacuum pump must be dehumidified.

- ▶ Close the appliance lid and press down.
- ▶ Touch the Ⓞ button.
 - The oil in the vacuum pump is being dehumidified.



The dehumidifying process takes a maximum of 20 minutes. If the  button remains illuminated, the process must be repeated.



It is necessary to wait for one hour between dehumidifying processes as the oil in the vacuum pump gets hot. During this time, the  and  buttons are illuminated, but they cannot be operated.

9 Trouble-shooting

9.1 What to do if ...

This section lists faults that can be solved simply by following the instructions given. If another fault is displayed or the fault cannot be remedied, please call Customer Services.

... the appliance is not working

| Possible cause | Solution |
|--|---|
| ▪ A household fuse or circuit breaker has tripped due to an overload. | ▶ Replace or switch the fuse back on. |
| ▪ The fuse or circuit breaker keeps blowing. | ▶ Call Customer Services. |
| ▪ An interruption in the power supply. | ▶ Check the power supply. |
| ▪ The appliance is faulty. | ▶ Call Customer Services. |
| ▪ Repeated vacuuming has caused the appliance to overheat. | ▶ Allow the appliance to cool down before using again. |
| ▪ The appliance is in a cooling phase between two dehumidifying processes. During this time, the  and  buttons are illuminated, but they cannot be operated. | ▶ Wait one hour before repeating the dehumidifying process. |

... insufficient vacuum in the bag

| Possible cause | Solution |
|---|--|
| ▪ The vacuuming level selected was too low for the particular foodstuff used. | ▶ Select the next highest level. |
| ▪ The suction inlet of the vacuum pump is obstructed. | ▶ Ensure the bag is not obstructing the suction inlet of the vacuum pump. |
| ▪ The bag is not airtight. | ▶ Vacuum seal the food in a new bag, selecting a higher level for the sealing time if necessary. |

... the vacuum bag is incorrectly sealed

| Possible cause | Solution |
|---|--|
| ▪ The sealing time set was insufficient for the vacuuming level selected. | ▶ Select the next highest sealing time level. |
| ▪ The vacuum bag is not positioned correctly on the sealing bar. | ▶ Position the vacuum bag correctly. |
| ▪ The vacuum bag is contaminated around the sealing seam. | ▶ Clean the sealing area before the process. |
| ▪ The seal pad, located on the appliance lid, is very worn. | ▶ Replace the seal pad. |
| ▪ Repeated vacuuming has caused the appliance to overheat. | ▶ Allow the appliance to cool down before using again. |

... the appliance lid will not open

| Possible cause | Solution |
|----------------------------------|---|
| ▪ The appliance is in operation. | ▶ Wait until the appliance is ventilated at the end of the process and an acoustic signal is emitted. |
| ▪ Power supply was interrupted. | ▶ Reconnect the power supply. The appliance is ventilated. |

... noises can be heard during operation

| Possible cause | Solution |
|---|-------------------------|
| ▪ Appliance can make noises during operation (e.g. switching and pumping noises). | ▶ Such noise is normal. |

... the maintenance button illuminates

| Possible cause | Solution |
|---|--|
| ▪ The appliance cannot reach the desired underpressure. | ▶ Hold the appliance lid down well when starting the vacuum-sealing process. ▶ Check the appliance lid gasket and the contact surface of the gasket and clean if necessary. If the gasket is not lying flat, smooth it out with a finger. ▶ Select a lower vacuuming level, e.g. for food with liquid. ▶ If the vacuum bag is protruding from under the appliance lid gasket, position the bag correctly. |
| ▪ The pump output is reduced. | ▶ Dehumidify the oil in the vacuum pump when the  button illuminates. |

... the liquid in the vacuum bag is boiling vigorously while being vacuumed

| Possible cause | Solution |
|--|---|
| <ul style="list-style-type: none"> ▪ Liquids already start to boil at low temperatures when under vacuum. | <ul style="list-style-type: none"> ▶ Sealing sooner. ▶ Select vacuuming level 1 for vacuum sealing liquid foodstuffs. ▶ Liquids or foods with a high liquid content should not be warmer than 10 °C. |

... very fragile and delicate food such as crisps and breakfast cereals is damaged during vacuum sealing

| Possible cause | Solution |
|---|--|
| <ul style="list-style-type: none"> ▪ The vacuuming level selected is too high. | <ul style="list-style-type: none"> ▶ Select vacuuming level «0». |
| <ul style="list-style-type: none"> ▪ There is not a sufficient air cushion in the bag. | <ul style="list-style-type: none"> ▶ Ensuring there is a sufficient air cushion in the bag, place it in the vacuum drawer |

... no vacuum is being created in the bottle during external vacuuming*

* Depending on the software version

| Possible cause | Solution |
|--|--|
| <ul style="list-style-type: none"> ▪ The tube and vacuum stopper are showing clear signs of wear and tear and therefore not sealing tightly so that no sufficient vacuum can be obtained. | <ul style="list-style-type: none"> ▶ Replace the tube and vacuum stopper with new ones. |

10 Accessories and spare parts

Please give model number of the appliance and exact designation of the accessory or spare part when ordering parts.

- Bag tray: For vacuum sealing flat foodstuffs
- Appliance lid gasket
- Cover for sealing bar
- Complete sealing bar
- Seal pad

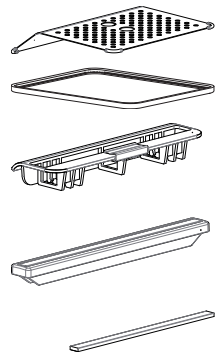

11 Technical data

- Vacuum bags:
Dimensions: 180 × 280 mm and 240 × 350 mm,
range of use: -40 to +115 °C



- Suction inlet adapter*
- Adapter for vacuum stopper*
- Tube*
- Vacuum stopper*

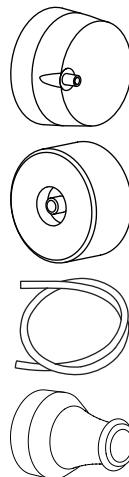

* Depending on the software version

11 Technical data

| Type | VS60144 |
|--|----------------------|
| Appliance measurements | |
| External dimensions (height × width × depth) | 142 × 596 × 547 mm |
| Capacity of vacuum tank (height × width × depth) | 95 × 350 × 285 mm |
| Volume of vacuum tank | 7.83 dm ³ |
| Empty weight | 25 kg |
| Electrical connection | |
| Connection | 220–240 V ~ 50/60 Hz |
| Connected load | 320 W |
| Fuse | 10 A |
| Stand-by consumption | 0.5 W |

12 Tips and tricks

Here are a few tips to make using your vacuum drawer even easier.

- Working hygienically: Hands, utensils and surfaces must be clean!
- The opening of the bag must lie completely flat on the sealing bar, without any overlap or wrinkles.
- Put only as much food into the bag as will allow it to be sealed closed at the top without any overlap or wrinkles.
- Make sure there is no liquid around the sealing seam. Fold the top of the bag down before filling it so as to keep the area where it is to be sealed clean. A funnel can be used as a filling aid. Place the bag to be filled in a measuring jug, then turn back the top of the bag a few centimetres.
- The last used settings for the «Vacuuming and sealing» application are saved, even when the appliance is switched off.
- To seal jars with screw-top lids under vacuum, lightly close the screw-top lids and place the jars in the vacuum drawer. These jars can be vacuumed and closed airtight at the same time using the «Vacuuming only» application.
- For liquids, to achieve maximum vacuum the liquid must be frozen before vacuuming.
- Vacuum seal large quantities of liquid not in vacuum bags but in solid containers with an appropriate volume. This makes for easier handling. External vacuuming is also possible given the use of suitable containers and the accessories.
- Freeze fruit before vacuum sealing it.
- Foodstuffs that do not have to be stored in the refrigerator such as cereals, flour, cake mixes, etc. can be preserved for longer by vacuum-packing them.
- Vacuuming is ideal for nuts, cereals, herbs and spices. Vacuum-packed, they remain fresh longer and do not go rancid.

13 Disposal

13.1 Packaging



Never allow children to play with packaging material due to the danger of injury or suffocation. Store the packaging material in a safe location or dispose of it in an environmentally-friendly way.

13.2 Safety

Render the appliance unusable to prevent accidents caused by improper use (e.g. through children playing):

- ▶ Disconnect the appliance from the mains. With a fixed appliance, this is to be carried out by a qualified electrician. Then cut the mains cable off flush with the appliance.

13.3 Disposal



-  The «crossed out wheeled bin» symbol requires the separate collection of waste electrical and electronic equipment (WEEE). Such equipment can contain hazardous, environmentally harmful materials.
- These appliances are to be handed over to a designated collection point for the recycling of electrical and electronic equipment and must not be disposed of with unsorted household waste. And in this way, you will be helping to protect resources and the environment.
- For more information, please contact the local authorities.

14 Index

| | |
|---------------------------------------|----|
| A | |
| Accessories | 21 |
| Appliance description | 7 |
| Appliance disposal | 23 |
| Applications | 14 |
| B | |
| Before using for the first time | 5 |
| C | |
| Cleaning..... | 16 |
| Accessories | 17 |
| Appliance lid gasket | 17 |
| Inside..... | 16 |
| Outside | 16 |
| Construction..... | 7 |
| D | |
| Dehumidifying..... | 18 |
| Display elements..... | 8 |
| Disposal..... | 23 |
| E | |
| Explanation of the displays..... | 8 |
| External vacuuming | 15 |
| F | |
| Food | 12 |
| Vacuum sealing | 12 |
| Food handling | 10 |
| G | |
| General notes | 16 |
| L | |
| Level for sealing time | |
| Selecting..... | 14 |
| M | |
| Model designation | 2 |
| Model number | 2 |
| N | |
| Notes..... | 25 |
| O | |
| Operating elements | 8 |
| Operating the appliance | 9 |
| Cancelling | 10 |
| Inserting bag..... | 9 |
| Starting process..... | 10 |
| Switching off before time | 10 |
| P | |
| Preparations | |
| Special types of food | 11 |
| Q | |
| Quality and hygiene..... | 10 |
| R | |
| Recommended vacuuming levels | 12 |
| Replacing appliance lid gasket..... | 17 |
| Replacing seal pad | 18 |
| S | |
| Safety precautions | |
| Appliance-specific | 4 |
| General | 4 |
| Sealing | 14 |
| Sealing bar | |
| Replacing | 17 |
| Sealing sooner | 10 |
| Selecting vacuuming levels | 12 |
| Service & Support..... | 27 |
| Sous-vide method | |
| Vacuisine | 11 |
| Spare parts | 21 |
| Storage | 11 |
| Symbols..... | 4 |
| System check | 18 |
| T | |
| Technical data | 22 |
| Technical questions..... | 27 |
| Tips and tricks | 22 |
| Type..... | 2 |
| U | |
| Using for the first time..... | 7 |
| V | |
| Vacuisine | 11 |
| Vacuuming | 14 |
| Validity..... | 2 |
| W | |
| Warranty extensions | 27 |

15 Notes

16 Service & Support



The «Trouble-shooting» section gives you valuable tips on how to deal with minor malfunctions yourself, saving you the time and trouble of calling out a service technician and any cost that goes along with it.

Information on the V-ZUG warranty can be found at www.vzug.com →Service →Warranty information. Please read this information carefully.

Please register your appliance straightaway online at www.vzug.com →Service →Warranty registration. This will allow you to take advantage of the best possible support in the event of a fault in the appliance during the guarantee period. You will require the serial number (SN) and appliance designation to register your appliance. You will find them on the identification plate of your appliance.

My appliance information:

SN: _____ **Appliance:** _____

Please have this appliance information to hand when contacting V-ZUG. Thank you.

- ▶ Open the vacuum drawer.
 - The identification plate is located on the left side panel.

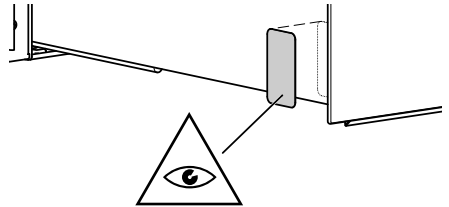

Your repair order

At www.vzug.com →Service→Service number you will find the telephone number of your nearest V-ZUG service centre.

Technical questions, accessories, warranty extensions

V-ZUG is happy to help you with any general administrative or technical queries, to take your orders for accessories and spare parts and to inform you about our progressive service agreements.

Quick instructions

Open appliance

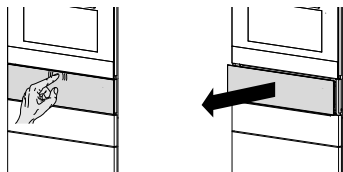

Switch appliance on

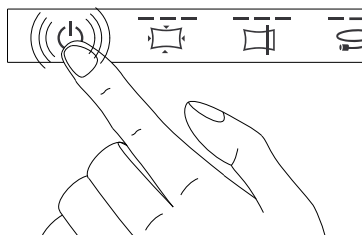

Operate vacuuming level

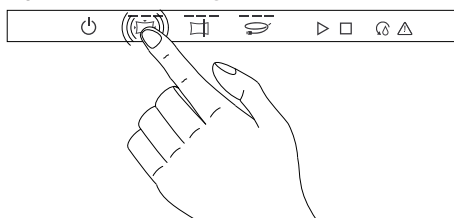

Operate level for sealing time

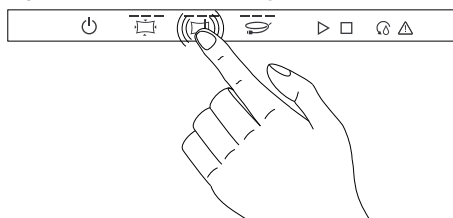

Vacuuming

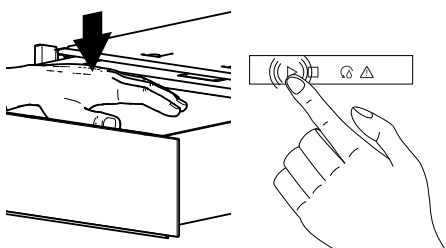

Switch appliance off and close

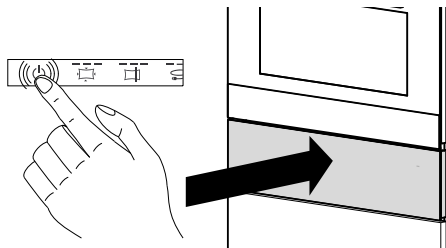

J36001352-R06

