

Oven

Combair SE

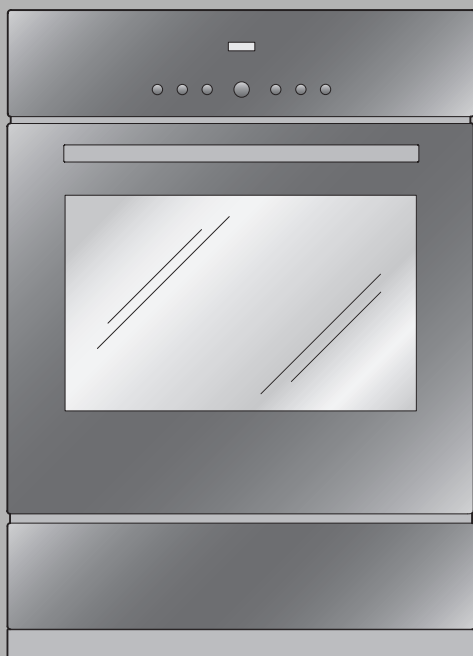

Operating instructions

Thank you for choosing to buy one of our products. Your appliance is made to high standards and is easy to use. Nevertheless, please take the time to read these operating instructions in order to familiarize yourself with the appliance and get the best use out of it.

Please follow the safety precautions.

Modifications

Text, diagrams and data correspond to the technical standard of the appliance at the time these operating instructions went to press. The right to make technical modifications for the purpose of the further development of the appliance is reserved.

Validity

The model number corresponds to the first 3 digits on the identification plate. These operating instructions apply to the models:

Type	Model no.	Size system
BCSE	41A	55-600/55-762
BCSE60	42A	60-600/60-762

Variations depending on the model are noted in the text.

Contents

1	Safety precautions	5
1.1	Symbols used	5
1.2	General safety precautions	6
1.3	Appliance-specific safety precautions	7
1.4	Instructions for use	9
2	Disposal	12
3	Appliance description	13
3.1	Construction	13
3.2	Operating and display elements	14
3.3	Cooking space	16
3.4	Accessories	17
4	Operating the appliance	18
4.1	Using for the first time	19
4.2	Selecting the operating mode	20
4.3	Selecting the cooking space temperature	20
4.4	Checking and changing the cooking space temperature	21
4.5	Changing the operating mode	21
4.6	Switching off	21
5	User settings	22
5.1	Childproof lock	24
5.2	Time display	24
5.3	Acoustic signal	25
5.4	Temperature unit	25
5.5	Time format	25
5.6	Mains synchronisation	25
5.7	Factory settings	25
6	Time functions	26
6.1	Setting and changing the time	26
6.2	Timer	27
6.3	Operating time	28
6.4	Delayed start	30

7	Operating modes	33
7.1	Top/Bottom heat	33
7.2	Top/Bottom heat humid	34
7.3	Bottom heat	34
7.4	Hot air	35
7.5	Hot air humid	36
7.6	PizzaPlus	37
7.7	Grill	37
7.8	Grill-forced convection	38
7.9	Fast heating	38
8	Tips and tricks	39
8.1	Baking and roasting	39
8.2	Cakes	39
8.3	Uneven browning	40
8.4	Saving energy	40
9	Option	41
9.1	Warming drawer	41
10	Care and maintenance	42
10.1	Cleaning the exterior	42
10.2	Cleaning the door seal	43
10.3	Replacing the door seal	43
10.4	Cleaning the appliance door	44
10.5	Cleaning the accessories and shelf guides	45
10.6	Cleaning the cooking space	46
10.7	Replacing the light bulb	46
11	Trouble-shooting	47
11.1	What to do if ...	47
11.2	After a power failure	50
12	Accessories and spare parts	51
13	Technical data	52
14	Index	53
15	Repair service	55

1 Safety precautions

1.1 Symbols used



Denotes important safety precautions. Failure to observe said precautions can result in injury or in damage to the appliance or fittings!



Information and precautions that should be observed.



Information on disposal.



Information about the Operating Instructions.

- Indicates step-by-step instructions.
- Describes how the appliance reacts to the steps taken.
- Indicates a list.

1.2 General safety precautions



- Read the operating instructions before using the appliance for the first time!



- This appliance is not intended for use by persons (including children) with reduced physical, sensory or mental capabilities, or lack of experience and/or knowledge, unless they are supervised or have been given instruction concerning use of the appliance by a person responsible for their safety.
- Children should be supervised to ensure that they do not play with the appliance.
- If the mains cable of this appliance is damaged, it must be replaced by the manufacturer or its Customer Services or a similarly qualified person in order to avoid hazard.

1.3 Appliance-specific safety precautions



- **WARNING:** The appliance and its accessible parts get hot during use. Be careful not to touch the heating elements.
- Children under 8 years of age must be kept away unless constantly supervised.
- This appliance can be used by children aged 8 and above and by persons with reduced physical, sensory or mental capabilities, or lack of experience and/or knowledge, provided they are supervised or have been instructed on the safe use of the appliance and have understood the hazards involved. Children shall not play with the appliance. Cleaning and user maintenance shall not be undertaken by children without supervision.
- **WARNING:** Accessible parts can get hot during use. Keep small children away.
- Do not use aggressive or abrasive cleaning agents or sharp metal scrapers for cleaning the glass in the oven door as they could scratch the surface. This can destroy the glass.

- A warming drawer and its contents get hot.
- For appliances with pyrolytic self-cleaning, excessive soiling and accessories must be removed before carrying out pyrolytic self-cleaning.
- Only use the food probe recommended for this oven.
- Under no circumstances use a steam cleaner.
- **WARNING:** Before replacing the light, ensure the appliance is switched off and disconnected from the mains power supply to avoid possible electric shock.
- **WARNING:** It can be dangerous to leave the hob unattended when cooking with fat or oil as this can lead to fires. **NEVER** attempt to extinguish a fire with water. Instead, switch the appliance off and then carefully smother the flames with, for example, a lid or a fire blanket.
- **WARNING:** Never store objects on the hob due to the risk of fire.

1.4 Instructions for use

Before using for the first time

- The appliance must be installed and connected to the mains supply in accordance with the separate installation instructions. Have a qualified fitter/electrician carry out the necessary work.

Correct use

- The appliance is designed for use in the home for preparing food. Under no circumstances flambé or cook food using a lot of fat in the cooking space! No liability is assumed for any damage caused by improper use or incorrect handling.
- Never use the appliance to dry animals, textiles or paper!
- Do not use the appliance as a room heater.
- The appliance should only be installed and operated at an ambient temperature of 5 °C to 35 °C. If there is a risk of frost, residual water left in the pumps can freeze and cause damage to them.
- Repairs, modifications or manipulations to the appliance, especially any electrically live parts, may only be carried out by the manufacturer, its Customer Services or a similarly qualified person. Repairs if carried out incorrectly may cause serious injury, damage to the appliance and fittings, as well as affect the functioning of the appliance. If the appliance is not working properly or in case of a repair order, follow the instructions given in the **REPAIR SERVICE** section. If necessary, please contact our Customer Services.
- Use original spare parts only.
- Retain these operating instructions for future reference.
- The appliance corresponds to recognized technology standards and the relevant safety regulations. Proper use of the appliance is essential to avoid damage and accidents. Please observe the precautions given in these operating instructions.

Note on use

- Use the childproof locking facility.
- If the appliance is visibly damaged, do not use it. Contact our Customer Services.
- If the appliance is not operating properly, disconnect it from the mains power supply immediately.
- Ensure there are no foreign bodies or pets in the cooking space before closing the appliance door.
- Do not store objects that could pose a danger if the appliance were accidentally switched on in the cooking space or the warming drawer. Do not store food or temperature-sensitive or inflammable materials, e.g. cleaning agents, oven sprays, in the cooking space.
- For appliances with a grill, keep the appliance door closed while grilling. The heat could otherwise damage the operating and display elements or the fitted unit above.

Caution: Risk of burns!

- The appliance gets very hot when in use. The appliance door also heats up.
- Steam may escape from the cooking space when the appliance door is opened.
- The heated appliance remains hot for some time after being switched off and cools down only slowly to room temperature. Allow sufficient time for the appliance to cool down before, for example, cleaning it.
- Overheated fat and oil can easily catch fire. Heating oil in the cooking space to sear meat is dangerous and should not be done. Never attempt to extinguish burning oil or fat with water. Danger of explosion! Smother the flames with a fire blanket. Keep doors and windows closed.
- Do not pour spirits (e.g. brandy, whisky, schnapps) over heated food. Danger of explosion!
- Do not leave the appliance unsupervised when drying herbs, bread, mushrooms, etc. If the foodstuff dries out too much, this can pose a fire hazard.
- If you notice smoke possibly coming from a fire in the appliance or inside the cooking space, keep the appliance door closed and disconnect the appliance from the mains power supply.
- Accessories get hot in the cooking space. Use protective gloves or oven cloths.

Caution: Risk of injury!

- Be careful not to put fingers in the door hinges. There is otherwise a risk of injury if the appliance door is moved. Particular care should be taken when children are around.
- Only leave the appliance door open in the at-rest position. An open appliance door poses a danger of tripping or injury! Do not sit or rest on the appliance door or use it as a storage surface.
- For hobs, a hob guard can be fitted to protect small children. These are available from specialized retailers.

Caution: Risk to life!

- Packaging materials, e.g. plastic and polystyrene, can be dangerous for children. Danger of suffocation! Keep packaging materials away from children.

How to avoid damaging the appliance

- Close the appliance door carefully.
- Do not place any objects directly on the bottom heating element.
- Do not use protective aluminium inserts with appliances with no visible bottom heating element.
- Do not use objects that can rust in the cooking space.
- Using knives or cutting wheels on the original baking tray will visibly damage the surface.
- To prevent corrosion, leave the appliance door open in the at-rest position until the cooking space has cooled down.
- When cleaning the appliance make sure no water can get into the inside of the appliance. Use a moderately damp cloth. Under no circumstances spray the inside or outside of the appliance with water. If water gets inside the appliance, it will cause damage.
- Do not leave the hotplates switched on at a high power level for any length of time without any cookware as this can damage them.

2 Disposal

Packaging

- All packaging materials (cardboard, plastic film (PE) and polystyrene (EPS)) are marked and should, if possible, be collected for recycling and disposed of in an environmentally friendly way.

Disconnection

- Disconnect the appliance from the mains power supply. With a fixed appliance, this is to be carried out by a qualified electrician!

Safety

- Disable the appliance to prevent accidents caused by improper use, especially through children playing.
- Pull the plug out of the mains socket or have the appliance disconnected from the mains by an electrician. Then cut the mains cable off flush with the appliance.

Disposal

- The old appliance should not be discarded as worthless rubbish. If disposed of correctly, the raw materials can be recovered for recycling.
- The  symbol on the identification plate warns that the appliance may not be disposed of in normal household waste.
- The appliance must be disposed of in accordance with local regulations on waste disposal. For more information on the handling, disposal and recycling of the product, please contact the local authorities, the local recycling facilities for household waste or the retailer from whom you purchased the appliance.

3 Appliance description

3.1 Construction

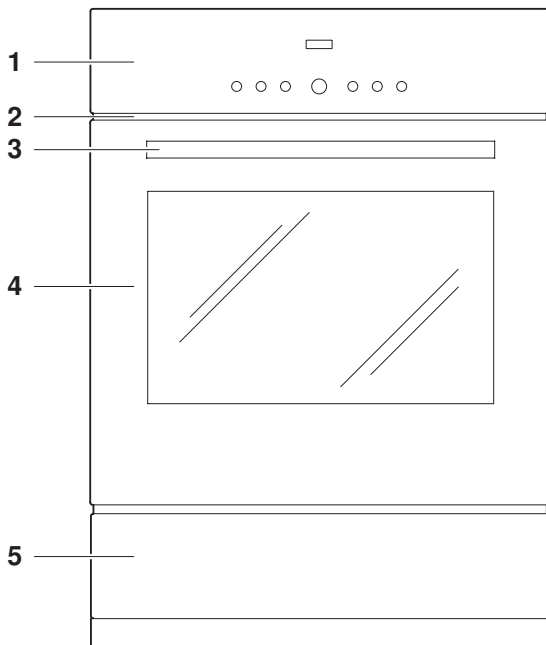

- 1 Operating and display elements
- 2 Ventilation opening
- 3 Door handle
- 4 Appliance door
- 5 Appliance/Warming drawer *

* Depending on model

3.2 Operating and display elements

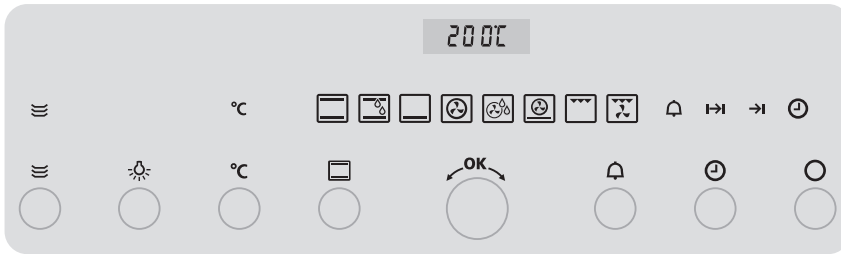

Digital displays

20 0C Temperature

14:25 Time
Operating time
Switch-off time
Timer

Operating mode symbols









- | | | | |
|--|-----------------------|---|-------------------------|
|  | Top/Bottom heat |  | Hot air humid |
|  | Top/Bottom heat humid |  | PizzaPlus |
|  | Bottom heat |  | Grill |
|  | Hot air |  | Grill-forced convection |

Symbols

	Warming drawer *		Operating time
	Cooking space temperature		Switch-off time
	Timer		Time

* Depending on model

Buttons

	Warming drawer *		Adjusting knob
	Illumination		Timer
	Cooking space temperature		Time
			Operating time
			Switch-off time
	Operating mode		Off

* Depending on model

3.3 Cooking space



Using protective inserts or aluminium foil can damage the appliance!

Do not place any protective insert or aluminium foil on the cooking space floor.

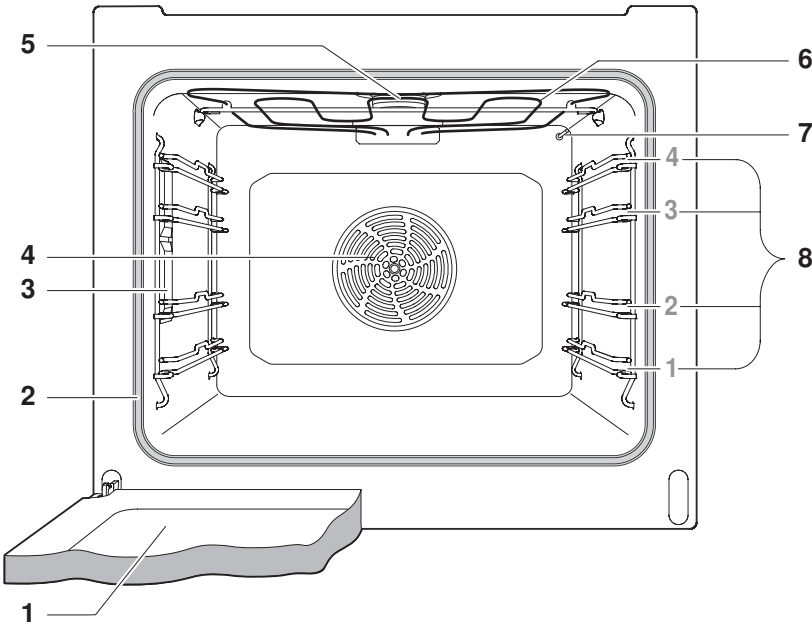

1 Appliance door

2 Door seal

3 Illumination

4 Hot air fan

5 Cooking space ventilation

6 Grill/Top heat

7 Cooking space temperature sensor

8 Levels (labelled)



The bottom heating element is beneath the cooking space floor.

3.4 Accessories



Incorrect handling can cause damage!

Do not use knives or cutting wheels to cut food in the accessories.

Original TopClean baking tray



- Baking tin for flans and biscuits
- Use together with the wire shelf as a drip tray
- If not fully covered by the baking, its shape can become distorted during baking. This is normal. It will go back to its original form as it cools down.
- Push the original baking tray into the cooking space with the «sloped» side **1** to the back.

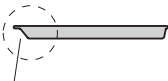

1

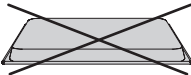

- Only use the normal way round – not upside down.

Wire shelf

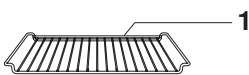

- For standing roasting and baking tins on
- For standing meat, frozen pizza, etc. on
- Push the bar **1** to the back of the cooking space. It enables the food to be removed safely from the cooking space.

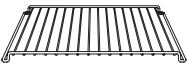

- Serves as a cooling rack.

Special accessories





Place any accessories not included in the scope of delivery on the wire shelf.

- Special accessories can be found at:
www.vzug.com

4 Operating the appliance

The operating mode, the cooking space temperature, the operating time, the switch-off time and various other functions can be selected – with the appliance switched off – by pressing the appropriate button once or more.

- The symbol for the function selected illuminates or flashes.
- A suggestion flashes in the display.
- Turn the  adjusting knob to change the setting.
- Press the  adjusting knob to confirm the setting or it will be taken over automatically after 10 seconds.
- Other settings or changes can be made at any time.
- Press the  button to switch off the appliance.

4.1 Using for the first time

Before operating the newly installed appliance for the first time, the following steps should be taken:

- Remove packaging and transport materials from the cooking space.
- If **12:00** flashes in the display, turn the  adjusting knob to set the time.



Press the  adjusting knob to toggle between hours and minutes.

Turn it to set hours and minutes.

Press the  adjusting knob to confirm the setting.

- Clean the cooking space and the accessories.
- Heat the empty cooking space (without wire shelves, baking trays, etc.) using the  operating mode at the maximum cooking space temperature for about 1 hour.











There is likely to be some smoke and odour given off, we therefore recommend ventilating the room well during this phase.



4.2 Selecting the operating mode

- ▶ Press the  button repeatedly until the desired operating mode flashes.
 - The recommended temperature flashes in the display.
 - The operating mode symbol and °C flash.







Operating modes

Press the  button	Operating mode	
1×		Top/Bottom heat
2×		Top/Bottom heat humid
3×		Bottom heat
4×		Hot air
5×		Hot air humid
6×		PizzaPlus
7×		Grill
8×		Grill-forced convection

4.3 Selecting the cooking space temperature

- ▶ Turn the  adjusting knob to set the desired temperature.
- ▶ Press the  adjusting knob to confirm.
 - The appliance starts.



For the , , , , ,  and  operating modes, a single acoustic signal is emitted when the cooking space temperature set is reached.

4.4 Checking and changing the cooking space temperature

- Press the °C button.
 - The cooking space temperature set flashes in the display.
 - The °C symbol flashes.
- Turn the  adjusting knob to change the cooking space temperature.

4.5 Changing the operating mode

- Press the  button repeatedly until the desired operating mode appears.

4.6 Switching off

- Press the  button.
 - A short acoustic signal is emitted.
 - The operating mode symbol and °C go out.



When the symbols are no longer illuminated, the appliance is off.
The cooling fan can continue to run.

Removing the cooked food from the cooking space



Risk of burns!











Hot air may escape from the cooking space when the appliance door is opened.

The accessories will be hot. Use protective gloves or oven cloths.

- Take the food out of the cooking space when done.
- Put baking on the wire shelf to cool.
- To prevent corrosion, leave the appliance door open in the at-rest position until the cooking space has cooled down.

5 User settings

You can adjust the settings.

- ▶ With the appliance switched off, hold the  adjusting knob depressed until
 -  appears in the display.
- ▶ Press the  adjusting knob to confirm.
 -  appears in the display for «Childproof lock off».
- ▶ Turn the  adjusting knob to select setting.
- ▶ Press the  adjusting knob to confirm.
 - E.g.  flashes in the display for «Time display visible».
- ▶ Turn the  adjusting knob to change the display to  for «Time display invisible».
- ▶ Press the  adjusting knob to confirm the setting.
- ▶ Press the  button to end the setting.



The settings are retained in the event of a power failure.



Possible settings

Childproof lock	$E-: 0$	off *
	$E-: 1$	on
Time display	$Eh: 1$	visible *
	$Eh: 0$	invisible
Acoustic signal	$ES: 2$	high *
	$ES: 1$	low
	$ES: 0$	off
Temperature unit	$Et: C$	°C *
	$Et: F$	°F
Time format	$EH:24$	24 h *
	$EH:12$	12 h
Mains synchronisation	$En: 0$	off
	$En: 1$	on *
Factory settings	$Er: 0$	no change
	$Er: 1$	restore



* Factory setting

5.1 Childproof lock



The childproof lock is to prevent the appliance being inadvertently switched on.

- If the  or  button is pressed when the childproof lock is activated,
- a double acoustic signal is emitted,
 - nothing happens when the button is pressed.

Operating the appliance when the childproof lock is activated

- ▶ Hold the  button depressed and press the  or  button.
 - The childproof lock is overridden.
 - The appliance can now be operated as normal.
 - The childproof lock is automatically reactivated 10 minutes after the appliance has been switched off.



The ,  and  buttons can be used irrespective of whether the childproof lock is activated or not.

5.2 Time display

If the «invisible» setting is selected, the displays are not illuminated when the appliance is off. The time is visible when the appliance is on.



To reduce power consumption to a minimum, select , «Time display invisible», in the user settings. Despite automatic energy-saving stand-by, all safety functions are active.

5.3 Acoustic signal

The acoustic signal can be set at one of two levels of loudness or can be switched off.

• high	maximum loudness
• low	reduced loudness
• off	Acoustic signal is switched off



Even if the acoustic signal setting is set to «off», an acoustic signal is emitted in the event of a malfunction.

Even if the acoustic signal setting is set to «off», a short acoustic signal is emitted when the appliance is switched off (safety function).

5.4 Temperature unit

For temperature unit, select between «°C» and «°F».

• °C	Degrees Celsius
• °F	Degrees Fahrenheit

5.5 Time format

Select the «24 h» setting to activate the European time format and the «12 h» setting for the US time format (a.m./p.m.).

5.6 Mains synchronisation

Mains synchronisation synchronises the appliance clock with the mains frequency. Irregular mains frequency can cause the clock to not run correctly. A pulse generator inside the appliance is used when mains synchronisation is switched off.

5.7 Factory settings

If one or more user settings have been changed, these can be reset to the factory settings.

6 Time functions

The following time functions are available:

- Time
- Timer
- Operating time – time-controlled switch-off of the appliance
- Delayed start – time-controlled switch-on and switch-off of the appliance











When the appliance is switched off, the time display is dimmed between 24:00 and 6:00.

If the **EH:12** time format has been selected, the display is not dimmed.

6.1 Setting and changing the time







The time cannot be changed if the appliance is in operation or if a delayed start has been set.

- Press the  button.
 - The hour flashes in the display.
 - The  symbol flashes.
- Turn the  adjusting knob to set the hour.
- Press the  button or the  adjusting knob.
 - The minutes flash in the display.
 - The  symbol flashes.
- Turn the  adjusting knob to set the minutes.
- Press the  adjusting knob to confirm the settings.



6.2 Timer

The timer functions like an egg timer. It can be used at any time and independently of all other functions.

Setting

- Press the  button.
 -  flashes in the display.
 - The  symbol flashes.
- Turn the  adjusting knob to set the duration.

The timer can be set for:



- up to 10 minutes in 10-second intervals, e.g.  = 9 mins. and 50 secs.
- over 10 minutes in 1-minute intervals, e.g.  = 1 hr and 12 mins.

The maximum timer duration that can be set is 9 hrs. and 59 mins.





Press the  button 1× to reset the timer duration to .

Starting



- Press the  adjusting knob to start the timer.
 - The countdown to the time remaining is visible in the display.
 - The  symbol illuminates.

Set duration finished





When the set duration is up

- a sequence of 5 short acoustic signals is repeated for 1 minute
- the  symbol flashes.
- Press the  button to switch off the appliance.

Checking and changing

- ▶ Press the  button.
 - The countdown to the time remaining flashes in the display.
 - The  symbol flashes.
- ▶ Turn the  adjusting knob to change the duration of the timer.







Switching off before time

- ▶ Press the  button 2×.
 -  flashes in the display.
 - The  symbol flashes.
- ▶ Press the  adjusting knob to confirm.



6.3 Operating time

The operating mode selected switches off automatically when the operating time is up.

Setting

- ▶ Select the desired operating mode and cooking space temperature.
- ▶ Preheat the cooking space if necessary.
- ▶ Place the food in the cooking space.
- ▶ Press the  button.
 -  flashes in the display.
 - The  symbol flashes.
- ▶ Turn the  adjusting knob to set the operating time (maximum of 9 hrs. 59 mins.).
- ▶ Press the  adjusting knob to confirm.
 - The countdown to the time remaining is visible in the display.
 - The  symbol illuminates.

Checking and changing

- Press the  button.
 - The countdown to the time remaining flashes in the display.
 - The I→I symbol flashes.
- Turn the  adjusting knob to change the operating time.

Switching off before time

- Press the  button.

End of the operating time

When the set duration is up

- the operating mode selected switches off automatically
- a long, intermittent acoustic signal is emitted for 1 minute
-  flashes in the display
- the I→I symbol flashes
- the settings remain for 3 minutes.

Extending the operating time

- Turn the  adjusting knob within 3 minutes to select a new duration.

Switching off

- Press the  button.
 - The settings are cleared.
 - The residual heat appears in the display.

6.4 Delayed start

The delayed start is activated when for the operating mode selected both an operating time and a switch-off time are set.





The appliance switches automatically on and off again at the desired times.







Perishables should not be kept unrefrigerated.

- ▶ Place the food in the cooking space.
- ▶ Select the desired operating mode and cooking space temperature.
- ▶ Do not press the  adjusting knob to confirm.

Setting the operating time

- ▶ Press the  button.
 -  flashes in the display.
 - The  symbol flashes.
- ▶ Turn the  adjusting knob to set the operating time (maximum of 9 hrs. 59 mins.).
- ▶ Do not press the  adjusting knob to confirm.

Setting the switch-off time

- ▶ Press the  button again.
 - Switch-off time – without a delayed start – e. g.  – flashes in the display.
 - The  symbol flashes.
- ▶ Turn the  adjusting knob to set the switch-off time.



The switch-off time can be delayed by a maximum of 23 hrs. and 59 mins.



If the **EH:12** time format has been selected, the switch-off time can be delayed by a maximum of 11 hrs. and 59 mins.

- Press the  adjusting knob to confirm.
 - The time appears in the display.
 - The **→I** symbol illuminates.
 - The operating mode selected remains switched off until the automatic start.

Example

- Select the  operating mode and 180 °C.
- At 8:00, set an operating time of 1 hr and 15 mins.
- Set the switch-off time to 11:30.
 - The appliance will automatically switch on at 10:15 and off again at 11:30.

Checking and changing

- Press the  button 1×.
 - The operating time is visible for 3 seconds.
- Press the  button 2×.
 - The switch-off time flashes and can be changed.



The operating time, operating mode and cooking space temperature cannot be changed.

Switching off before time

- Press the  button.

End of the operating time

When the set duration is up

- the operating mode selected switches off automatically
- a long, intermittent acoustic signal is emitted for 1 minute
- **0'00** flashes in the display
- the I→I symbol flashes
- the settings remain for 3 minutes.

Extending the operating time

- Turn the  adjusting knob within 3 minutes to select a new duration.

Switching off

- Press the  button.
 - The settings are cleared.
 - The residual heat appears in the display.

7 Operating modes

All operating modes along with Fast heating are described below.

- ▶ Place tins, moulds, etc. on the wire shelf.
- ▶ Push the original baking tray into the cooking space with the «sloped» side to the back.
- ▶ The desired operating mode can be selected by pressing the  button once or more.



Follow the advice in **TIPS AND TRICKS** and in the separate **TIPS ON SETTINGS**.

7.1 Top/Bottom heat

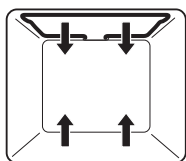

Temperature range	30–280 °C
Recommended value	200 °C
Level	2 (or 1)

The cooking space is heated by the top and bottom heating elements.

Use

- Classic operating mode for cooking and baking on 1 level
- Cakes, biscuits, bread and roasts
- ▶ Use a dark enamelled tray or a black tray or tin for crispy results.



7.2 Top/Bottom heat humid

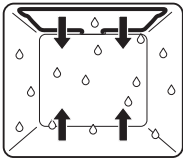

Temperature range	30–280 °C
Recommended value	200 °C
Level	2 (or 1)

The cooking space is heated by the top and bottom heating elements. The steam produced is largely retained in the cooking space. The food retains its moisture.

Use

- Bread, yeast pastries, roasts and gratins on 1 level
- Low temperature cooking

7.3 Bottom heat

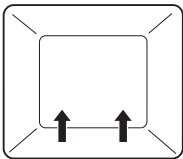

Temperature range	30–250 °C
Recommended value	200 °C
Level	2 (or 1)

The cooking space is heated by the bottom heating element.

Use

- Intensive baking of flan bases
- Preserving food



► Use a dark enamelled tray or a black tray or tin for crispy results.

7.4 Hot air

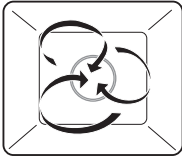

Temperature range	30–250 °C
Recommended value	180 °C
Level	1 + 3 or 2 (or 1 + 2 + 3)

A heating element behind the back wall of the cooking space heats up the air inside the cooking space, which is circulated evenly.

Use

- Particularly suitable for baking savouries and biscuits on several levels at the same time
- Cakes, bread and roasts



- ▶ Select a lower temperature (reduce by approximately 20 °C) than for  as the heat transfer is more efficient.

7.5 Hot air humid

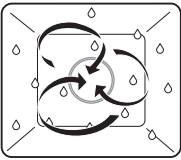

Temperature range	30–250 °C
Recommended value	180 °C
Level	1 + 3 or 2 (or 1 + 2 + 3)

A heating element behind the back wall of the cooking space heats up the air inside the cooking space, which is circulated evenly. The steam produced is largely retained in the cooking space. The food retains its moisture.

Use

- Yeast pastries and bread on several levels at the same time
- Gratins and baked dishes



► Select a lower temperature (reduce by approximately 20 °C) than for  as the heat transfer is more efficient.

7.6 PizzaPlus

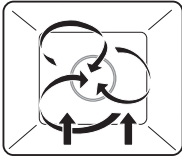

Temperature range	30–250 °C
Recommended value	200 °C
Level	2 (or 1)

The cooking space is heated by hot air and bottom heat. The base of the food is baked particularly intensively.

Use

- Pizza
- Flans and quiches



- ▶ Use a dark enamelled tray or a black tray or tin without baking paper for particularly crispy results.

7.7 Grill

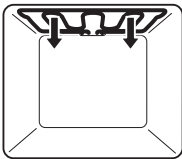

Temperature range	30–280 °C
Recommended value	250 °C
Level	3 or 4

The cooking space is heated by the grill element.

Use

- Flat food for grilling, e.g. steaks, chops, chicken parts, fish and sausages
- Gratinating
- Toast



- ▶ Place the food to be grilled directly onto the wire shelf.
- ▶ Line the original baking tray with aluminium foil and then place it underneath the wire shelf.

7.8 Grill-forced convection

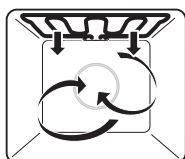

Temperature range	30–250 °C
Recommended value	200 °C
Level	2 or 3

The cooking space is heated by the grill element. The hot air fan distributes the air evenly in the cooking space.

Use





- Large, bulky food for grilling
- Gratins and baked dishes





Particularly suitable for a whole chicken.

- ▶ Place the food to be grilled in a porcelain or glass dish or directly on the wire shelf.
- ▶ Line the original baking tray with aluminium foil and then place it underneath the wire shelf.

7.9 Fast heating

Fast heating can be used to shorten the preheating time. Fast heating can be used only with the , , ,  and  operating modes.

- ▶ Select the desired operating mode and cooking space temperature.
- ▶ Hold the  adjusting knob depressed until
 - a single acoustic signal is emitted
 -  flashes in the display

An acoustic signal is emitted when the set cooking space temperature is reached.

8 Tips and tricks





8.1 Baking and roasting

Result	Solution
<ul style="list-style-type: none">• The baking or roast looks good on the outside but is still doughy or raw on the inside.	<ul style="list-style-type: none">➤ Next time, set a lower cooking space temperature and lengthen the operating time.

8.2 Cakes

Result	Solution
<ul style="list-style-type: none">• The cake collapses.	<ul style="list-style-type: none">➤ Check the settings with those given in the separate TIPS ON SETTINGS.➤ Next time, set a lower cooking space temperature and lengthen the operating time.➤ Stir the cake mixture well. When finished, bake immediately.➤ For whisked sponges, beat the egg yolks/ egg whites to a foam for a little longer and then carefully fold into the mixture. When finished, bake immediately.➤ Follow the instructions on how much baking powder to add.





8.3 Uneven browning

Result	Solution
<ul style="list-style-type: none"> The baking has browned unevenly. 	<ul style="list-style-type: none"> Next time, set a lower cooking space temperature and adjust the operating time. If using ,  or , check that the levels selected are as recommended in the separate TIPS ON SETTINGS. Select  if baking on one level. Do not push baking tins or large, bulky foodstuff right to the back of the cooking space.
<ul style="list-style-type: none"> The baking has come out lighter on one baking tray than on the other. 	<ul style="list-style-type: none"> Check the settings with those given in the separate TIPS ON SETTINGS.



Some uneven browning is normal. More even browning is generally achieved at lower cooking space temperatures.

8.4 Saving energy

The  and  operating modes consume less energy than the  and  operating modes.

- Avoid opening the appliance door frequently.
- Only switch the illumination on when needed.
- Use residual heat: for longer cooking times, i.e. over 30 minutes, switch the appliance off 5–10 minutes before the end of the cooking time. Exceptions: soufflé, sponge, choux pastry and puff pastry.
- Minimise preheating.
- Only preheat the cooking space if the baking results depend on it.



You can reduce the power consumption to a minimum by selecting , «Time display invisible», in the user settings. Despite automatic energy-saving stand-by, all safety functions are active.

9 Option

9.1 Warming drawer



**Unauthorized storage of materials creates a fire hazard!
Do not store any foodstuffs or combustible or flammable materials
in the warming drawer.**

The warming drawer can be used to preheat the tableware or to briefly keep covered food warm.

- ▶ Press the  button to switch the warming drawer on and off.
- ▶ Preheat the tableware for about 1 hour.



The warming drawer switches off automatically after 12 hours.

10 Care and maintenance



Risk of burns from hot surfaces!

Allow the appliance and the accessories to cool down before cleaning.

Incorrect handling can result in damage to the appliance!

Do not use any abrasive or caustic cleaning agents, sharp or rough metal scrapers, steel wool, abrasive scouring pads, etc. These products will scratch the surfaces. Glass surfaces that are scratched can crack.

Under no circumstances use a steam cleaner to clean the appliance.

10.1 Cleaning the exterior

- Remove any soiling or excess cleaning solution immediately.
- Clean the surfaces with a soft cloth dampened with water and a little washing-up liquid – for metallic surfaces rub in the direction of the original polish lines. Dry with a soft cloth.

Appliance/Warming drawer

The drawer can be removed for ease of cleaning.

- Pull out the drawer as far as the stopper will allow, lift slightly and remove from the front.

10.2 Cleaning the door seal

- Clean the door seal with a soft cloth dampened with water, but do not use any cleaning agent. Dry with a soft cloth.

10.3 Replacing the door seal

- Remove the damaged door seal.
- Clean the groove **1** with a slightly damp cloth.
- Press the ends of the new door seal into the groove at the centre bottom of the frame.



The ends must touch one another but not overlap.

- Ensure that only the thinner part **3** of the seal is pressed into the groove; the thicker part **4** may not be in the groove.

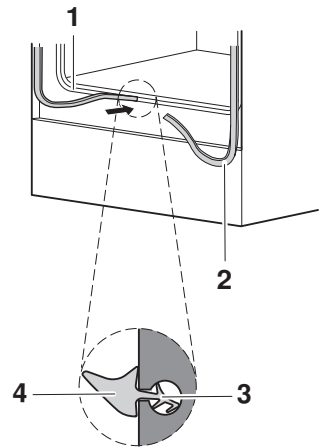

- Starting from the bottom, press the seal evenly into the groove.

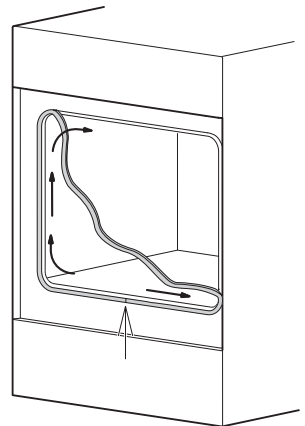

10.4 Cleaning the appliance door

- ▶ Clean the appliance door with a soft cloth dampened with water and a little washing-up liquid. Dry with a soft cloth.

Removing the appliance door



Risk of injury from moving parts!

Be careful not to put fingers in the door hinges. When removing and reassembling the appliance door, hold it firmly at the sides with both hands. The appliance door is heavy.

- ▶ Open the appliance door as far as it will go.
- ▶ Fold the clips **2** on both door hinges **1** forward.

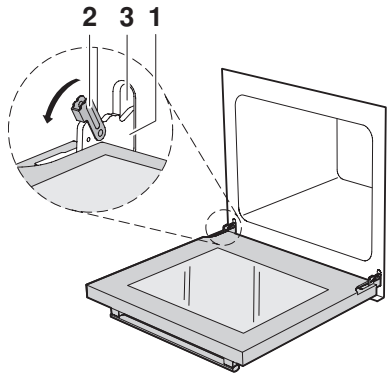

- ▶ Close the appliance door as far as its at-rest position (about 30°).
- ▶ Lift the appliance door out at an angle.

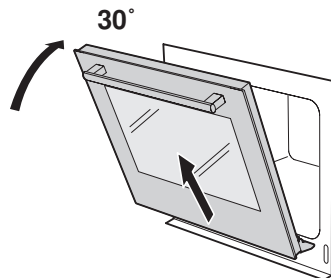

Reassembling the appliance door

- ▶ From the front, push both hinges **1** into the opening **3**.
- ▶ Open the appliance door as far as it will go and close back the clips **2**.

10.5 Cleaning the accessories and shelf guides

- The wire shelf and shelf guides can be cleaned in the dishwasher.
- The original baking tray can be cleaned in the dishwasher; however, this will affect its TopClean non-stick properties.

Removing and reassembling the shelf guides

- Press the shelf guides at the top back and remove from the opening.

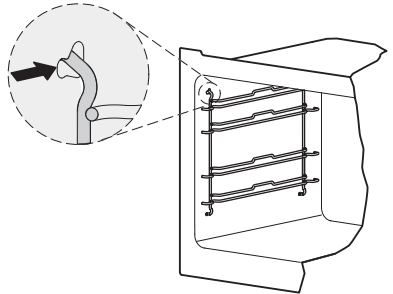

- Swing the shelf guides down into the middle of the cooking space and remove from the opening at the bottom.
- Reassemble in reverse order.

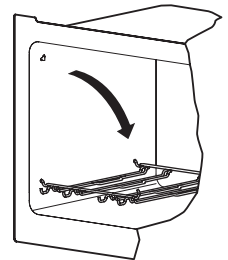

10.6 Cleaning the cooking space



Incorrect handling can result in damage to the appliance!
Do not bend the temperature sensor or heating elements.
Do not scour the surface. This will damage the TopClean non-stick properties.

- Remove any soiling from the cooking space while still hand warm using a soft cloth dampened with water and a little washing-up liquid. Wipe dry with a soft cloth.
- Use a commercially available oven cleaner and follow the manufacturer's instructions.

10.7 Replacing the light bulb



WARNING: Risk of electric shock!
Disconnect the appliance from the mains power supply before replacing the light bulb.
Risk of burns from hot surfaces!
Allow both the light bulb and appliance to cool down before replacing the light bulb.

- Remove the left shelf guide.
- Place a screw driver at the edge of the glass light cover in the middle and carefully release the glass light cover **1** from its fixture.
- Unscrew the defective light bulb.
- Carefully screw in the new light bulb.
- Press the glass light cover **1** back into its fixture.
- Replace the shelf guide.
- Reconnect the appliance to the mains power supply.

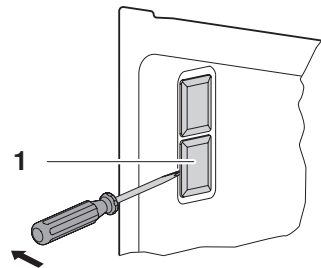

11 Troubleshooting

This section lists faults that can be solved simply by following the instructions given. If another fault is displayed or the fault cannot be remedied, please call Customer Services.

Before calling Customer Services:

- ▶ Please note down the serial number (FN) (see **TECHNICAL DATA** for the identification plate) and the error message in full, e.g. **F xx** or **E xx**.

11.1 What to do if ...

... the appliance is not working and the displays are not illuminated

Possible cause	Solution
<ul style="list-style-type: none">• A household fuse or circuit breaker has tripped.	<ul style="list-style-type: none">▶ Change the fuse.▶ Reset the circuit breaker.
<ul style="list-style-type: none">• The fuse or circuit breaker keeps blowing.	<ul style="list-style-type: none">▶ Call Customer Services.
<ul style="list-style-type: none">• An interruption in the mains power supply.	<ul style="list-style-type: none">▶ Check the mains power supply.

... just the illumination is not working

Possible cause	Solution
<ul style="list-style-type: none">• Light bulb is defective.	<ul style="list-style-type: none">▶ Replace the light bulb.

... when grilling, thick smoke is given off

Possible cause	Solution
<ul style="list-style-type: none"> • The food is too near to the heating elements. 	<ul style="list-style-type: none"> ➤ Check that the level selected is as recommended in the TIPS ON SETTINGS.
<ul style="list-style-type: none"> • The cooking space temperature is too high. 	<ul style="list-style-type: none"> ➤ Reduce the cooking space temperature.

... in the display appears

Possible cause	Solution
<ul style="list-style-type: none"> • The childproof lock is activated. 	<ul style="list-style-type: none"> ➤ For operating the appliance when the childproof lock is activated, see USER SETTINGS. ➤ Switch off the childproof lock.

... the following displays flash alternately

F xx and E xx

Possible cause	Solution
<ul style="list-style-type: none"> • Various situations can lead to an error message. 	<ul style="list-style-type: none"> ➤ Cancel the error message by pressing the  button. ➤ Disconnect the power supply for about 1 minute. ➤ Reconnect the power supply. ➤ If the error message appears again, note down the error message in full along with the serial number (FN) (see identification plate). ➤ Disconnect the power supply. ➤ Call Customer Services.

... the following displays flash alternately

U xx and **E** xx



Possible cause	Solution
<ul style="list-style-type: none"> • An interruption in the power supply. 	<ul style="list-style-type: none"> ➤ Cancel the error message by pressing the  button. ➤ Disconnect the power supply for about 1 minute. ➤ Reconnect the power supply. ➤ If the error message appears again, note down the error message in full along with the serial number (FN) (see identification plate). ➤ Disconnect the power supply. ➤ Call Customer Services.





... the clock is not running correctly

Possible cause	Solution
<ul style="list-style-type: none"> • Irregular mains frequency. 	<ul style="list-style-type: none"> ➤ Switch off the mains synchronisation.
When mains synchronisation is switched off: <ul style="list-style-type: none"> • internal pulse generator is imprecise. 	<ul style="list-style-type: none"> ➤ Call Customer Services.

11.2 After a power failure

After a power failure

-  flashes in the display
- the  symbol flashes

- ▶ Turn the  adjusting knob to set the hour.
- ▶ Press the  adjusting knob to confirm.
- ▶ Turn the  adjusting knob to set the minutes.
- ▶ Press the  adjusting knob to confirm.



The user settings remain unchanged.

12 Accessories and spare parts

Please give model number of the appliance and exact description of the accessory or spare part when ordering parts.

Accessories

Original baking tray



Wire shelf

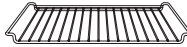

Tips on settings



Special accessories

For information see:

www.vzug.com

Spare parts

Shelf guides
left/right

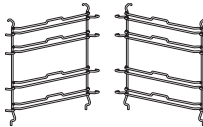

Light bulb

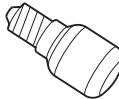

Door seal

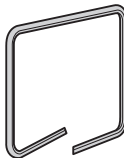

The light bulb is also available from specialist retailers.

13 Technical data

External dimensions



- See Installation Instructions

Electrical connection

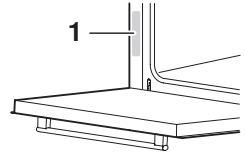
- See identification plate 1



Note for testing institutes

The energy efficiency class according to EN 50304/EN 60350 is determined using the  and  operating modes. Placing thermocouples between the appliance door and the seal may result in leakage and thus in incorrect measurements.

The usable volume within the meaning of EN 50304/EN 60350 is obtained with the shelf guides disassembled.

Measurement of the temperature in the cooking space

The temperature in the cooking space is measured when the cooking space is empty according to an internationally accepted standard. Own measurements may be inaccurate and are not suitable for checking the accuracy of the temperature.

Automatic energy-saving stand-by

To avoid consuming power unnecessarily, the appliance is equipped with automatic energy-saving stand-by.



To reduce power consumption to a minimum, select , «Time display invisible», in the user settings. Despite automatic energy-saving stand-by, all safety functions are active.

14 Index

- A**
Accessories 17, 51
 Cleaning 45
Acoustic signal 23, 25
and 33
Appliance description 13
Appliance door
 Removing 44
Appliance drawer 13
 Cleaning 42
Appliance:Switching off 18
- B**
Before using for the first time 9
Bottom heat 16, 34
Buttons 15
- C**
Care 42
Childproof lock 23, 24
 Display 48
Cleaning 42
Construction 13
Cooking space
 Cleaning 46
 Temperature measurement 52
Cooking space temperature
 Checking and changing 21
 Selecting 20
- D**
Delayed start 30
Digital displays 14
Disconnection 12
Display elements 14
Disposal 12
Door seal
 Cleaning 43
 Replacing 43
- E**
Electrical connection 52
Exterior
 Cleaning 42
External dimensions 52
- F**
F and E error messages 48, 49
Factory settings 23, 25
Fast heating 38
- G**
Grill 37
Grill-forced convection 38
- H**
Hot air 35
Hot air humid 36
- I**
Identification plate 52
Illumination 47
Instructions for use 9
- L**
Levels 16
Light bulb 46
- M**
Mains synchronisation 25
Maintenance 42
Model no. 2
- O**
Operating 20
Operating elements 14
Operating modes 14, 33
 Changing 21
 Selecting 20
Operating the appliance 18
Operating time 28
Option 41
Original baking tray 17

-
- P**
Packaging 12
PizzaPlus 37
Power failure 50
Preheating 40
- Q**
Quick instructions 56
- R**
Removing food from cooking
space. 21
Repair service 55
- S**
Safety. 12
Safety precautions
 Appliance-specific 7
 Before using for the first time 9
 Correct use 9, 10
 General 6
Saving energy 40
Setting the switch-off time 30
Setting the time 26
Shelf guides
 Cleaning 45
 Removing 45
Spare parts 51
Special accessories. 17, 51
Stand-by 52
Switching off 18, 21, 29, 32
Switching off the appliance 21
Switch-off time 30
Symbols. 5, 15
- T**
Technical data 52
Temperature sensor 16
Temperature unit 23, 25
Testing institutes 52
Time
 Setting 26
Time display 23, 24
Time format 23, 25
Time functions 26
Timer 27
Tips and tricks 39
Tips on settings 51
Top/Bottom heat 33
Top/Bottom heat humid 34
Trouble-shooting 47
Type 2
- U**
Uneven browning. 40
User settings 22
Using for the first time 9, 19
- V**
Validity. 2
- W**
Warming drawer 13, 41
 Cleaning 42
Wire shelf 17

15 Repair service



The **TROUBLE-SHOOTING** section will help you to carry out small repairs yourself, saving you the time and trouble of calling out a service technician and the cost that goes along with it.

Whether you contact us about a malfunction or an order, please always state the serial number (FN) and the model type of your appliance. Enter these details below and also on the service sticker which comes with the appliance. Stick it in a conspicuous place or in your telephone or address book.

FN

Appliance





You will also find the same details on the certificate of guarantee, the original sales invoice and the identification plate of the appliance.

- ▶ Open the appliance door.
 - The identification plate is on the left-side panel.



Quick instructions

Please first read the safety precautions in the operating instructions!

To set the time

- Press the  button.
- Turn the  adjusting knob to set the hour.
- Press the  button again.
- Turn the  adjusting knob to set the minutes.



To select the operating mode

- Press the  button repeatedly until the desired operating mode appears.
- Turn the  adjusting knob to set the cooking space temperature.

To switch off the appliance

- Press the  button.

To set the timer

- Press the  button.
- Turn the  adjusting knob to set the timer duration.

V-ZUG Ltd

Industriestrasse 66, CH-6301 Zug
vzug@vzug.ch, www.vzug.com



J41A.352-0