

Operating instructions

Prestige

Refrigerator/freezer

Thank you for choosing to buy one of our products. Your appliance is made to high standards and is easy to use. Nevertheless, please take the time to read these operating instructions in order to familiarize yourself with the appliance and get the best use out of it.

Please follow the safety precautions.

Modifications

Text, diagrams and data correspond to the technical standard of the appliance at the time these operating instructions went to press. The right to make technical modifications for the purpose of the further development of the appliances is reserved.

Validity

The model number corresponds to the first alphanumeric on the identification plate. These operating instructions apply to:

Model designation	Model number	Size system
Prestige	51044	Euro 60

Variations depending on the model are noted in the text.

Table of contents

1	Safety precautions	4	11.3	Note for testing institutes	21
1.1	Symbols used.....	4	12	Disposal	22
1.2	General safety precautions.....	4	13	Index	23
1.3	Appliance-specific safety precautions	5	14	Service & Support	27
1.4	Appliance installation	5			
1.5	Instructions for use.....	5			
2	Using for the first time	8			
3	Appliance description	8			
3.1	Structure	8			
3.2	Operating and display elements.....	9			
4	Operation	9			
5	Special functions	11			
5.1	Fast cooling	11			
5.2	Fast freezing	12			
5.3	Holiday mode	12			
5.4	Sabbath mode.....	12			
6	Glass shelves and door trays	12			
6.1	Positioning door trays.....	12			
6.2	Positioning glass shelves.....	13			
7	Tips and tricks	13			
7.1	General information on using the appliance..	13			
7.2	Storing food	14			
7.3	Notes on refrigerating and freezing food.....	14			
7.4	Notes on saving energy	15			
8	Care and maintenance	15			
8.1	Cleaning	15			
8.2	Defrosting.....	16			
8.3	Changing the LED lighting.....	17			
9	Noises and alarms	18			
9.1	Operating noise	18			
9.2	Warning and alarm signals.....	19			
10	Trouble-shooting	20			
11	Technical data	21			
11.1	Food safety contact.....	21			
11.2	Temperature measurement	21			

1 Safety precautions

1.1 Symbols used



Denotes important safety precautions.

Failure to observe said precautions can result in injury or in damage to the appliance or fittings!



Information and precautions that should be observed.



Information on disposal



Information about the Operating Instructions



Remove plug from mains socket / disconnect power supply



Insert plug into mains socket / connect power supply



Do not cut off or modify mains plug



Wear protective gloves



Symbol ISO 7010 W021
WARNING: Risk of fire / flammable materials

- ▶ Indicates step-by-step instructions.
 - Describes how the appliance reacts to the steps taken.
- Indicates a list.

1.2 General safety precautions



- Read the operating instructions before using the appliance for the first time!



- This appliance can be used by children aged 8 and above and by persons with reduced physical, sensory or mental capabilities, or lack of experience and/or knowledge, provided they are supervised or have been instructed on the safe use of the appliance and have understood the hazards involved. Children shall not play with the appliance. Cleaning and user maintenance shall not be undertaken by children without supervision.
- If an appliance is not equipped with a mains cable and a plug or other means for disconnecting from the mains with a contact opening on each pole complying with the conditions of overvoltage category III for full isolation, an isolating device must be incorporated into the permanently installed electrical installation in accordance with the installation regulations.
- If the mains cable of this appliance is damaged, it must be replaced by the manufac-

turer or its Customer Services or a similarly qualified person in order to avoid hazard.

1.3 Appliance-specific safety precautions



- Children aged from 3 to 8 years are allowed to load and unload refrigerating appliances.

1.4 Appliance installation



- The appliance must be installed by qualified personnel only.
- Each step must be carried out and checked in full in the order specified.
- Electrical connections must be carried out by qualified personnel in accordance with the guidelines and standards for low-voltage installations and the specifications of the local electricity supply companies.
- A plug-in appliance may only be connected to a socket outlet with earthing contact, installed according to specifications. An all-pole mains isolating device with 3 mm contact opening should be provided in the house wiring system. Switches, plug and socket devices, circuit breakers and fusible cut-outs which are accessible after installation and which have all-poles switching are permissible as isolating devices. Effective earthing and separately installed neutral and earth conductors ensure safe and fault-free operation. After installation, live parts and cables with basic insulation must not be accessible. Check old installations.

- Refer to the identification plate for information on the required mains voltage, current type and fuse protection.
- All plastering, plasterboarding, wall papering or painting work is to be carried out prior to installing the appliance.
- Efficient repairs can only be guaranteed if it is possible to de-install the complete appliance at any time without causing any damage.
- Allow a 200 cm² ventilation opening/niche both top and bottom to ensure ideal ventilation.
- The direction of the door opening can be changed. This requires the corresponding hinge and panel covers (depending on model). Thickness of wood of door leaf: 16–20 mm. Use the hinge bolts supplied if the door leaf thickness >19 mm. This restricts the opening angle to 90°.

1.5 Instructions for use

Before using for the first time

- The appliance must be installed and connected to the electricity supply in accordance with the separate installation instructions. Have a qualified fitter/electrician carry out the necessary work.
- Electrical safety (protection against contact) must be ensured by the installation.
- If the appliance is visibly damaged, do not use it. Contact our Customer Services. Do not use the appliance if the cold circuit is damaged.
- **WARNING:** The required room volume for the appliance is at least 1 m³ per 8 g refrigerant (isobutane R600a). In rooms that are too small, a leak can produce a flammable air-gas mixture. The filled volume of the refrigerant is shown on the identification plate.
- **WARNING:** When installing the appliance, ensure the mains cable is not trapped or damaged.

1 Safety precautions

- **WARNING:** Do not locate multiple portable socket-outlets or portable power supplies at the rear of the appliance.
- Avoid using extension cables.
- When installed, it is important to ensure that the air inlets and vent openings are not covered or blocked.
- Retain these operating instructions for future reference.
- Operating instructions for the appliance can be downloaded from www.vzug.com.
- Dispose of the packaging material in accordance with local regulations.

Correct use

- The appliance is designed for use in the home for cooling and storing food. The appliance must only be used as described in the operating instructions.
- This appliance is intended for use in the home and similar settings such as: in staff kitchens in shops, offices and other commercial establishments; in agricultural establishments; by guests in hotels, motels and other accommodation establishments; in bed and breakfast establishments. This appliance is not intended for use in the professional sector.
- The appliance corresponds to recognized technology standards and the relevant safety regulations. Proper use of the appliance is essential to avoid damage and accidents. Please therefore follow the precautions given in these operating instructions.
- No liability is assumed for any damage caused by improper or incorrect use or by repairs carried out by an unqualified person. In this case any warranty or other liability claims are deemed null and void.
- Any repairs, modifications or manipulations to the appliance, especially any electrically live parts, may only be carried out by the manufacturer, its Customer Services or a similarly qualified person. Repairs if carried out incorrectly may cause serious injury, damage to

the appliance and fittings, as well as affect the functioning of the appliance. If the appliance is not working properly or in case a repair is needed, follow the instructions given in the «Service & Support» section. Contact our Customer Services if necessary.

- Use original spare parts only.

Note on use

- Do not operate any electrical devices inside the refrigerator compartment and/or freezer compartment.
- High-proof alcohol should only be stored tightly sealed and standing upright. Do not store explosive materials or aerosol cans in the appliance. Danger of explosion!
- This appliance is CFC- and FC-free and contains small quantities of the environmentally friendly, but flammable refrigerant isobutane (R600a). When handling the appliance take care not to damage the cooling circuit. Any refrigerant that escapes can ignite. If it were to become damaged, avoid open flames and other ignition sources as isobutane is flammable. Ventilate the room well for a few minutes. Switch the appliance off and disconnect from the power supply. Do not turn on any power supplies. Notify our Customer Services.

Caution: Risk of injury!

- Be careful not to put fingers in the door hinges, as there is otherwise a risk of injury if the appliance door is moved. Particular care should be taken when children are around.
- Cut the power going to the appliance before cleaning. Pull out the mains plug or switch off the fuse. Never pull the mains plug out of the mains socket by the cable or with wet hands. Hold the mains plug and pull it straight out of the mains socket.

- Avoid prolonged skin contact with frozen food. Never consume frozen food or ice cubes that are straight out of the freezer compartment or too cold. Risk of burns from freezing!
- Do not remove the evaporation tray on the compressor. Fire hazard!
- Do not place bottles or cans of drink in the freezer compartment. Especially those containing carbonated drinks can burst during freezing.

Caution: Risk to life!

- Packaging materials, e.g. plastic film and polystyrene, can be dangerous for children. Danger of suffocation! Keep packaging material away from children.
- When carrying out maintenance work on the appliance, including replacing light bulbs (if how to remove them is described in the Operating instructions), cut off the electricity supply to the appliance: remove the screw fuse from the holder or switch the circuit breaker off, or unplug from the mains socket.

How to avoid damaging the appliance

- Clean the appliance just with water or a mild soapy solution (water and washing-up liquid).
- Do not use pointed or sharp objects to remove layers of ice or frozen-on food.
- No mechanical or artificial means other than those recommended may be used to accelerate defrosting.
- Store oils and fats upright in closed containers. They must not come into contact with the plastic parts or the door seal.

2 Using for the first time

Before operating the newly installed appliance for the first time, the following steps should be taken:

- ▶ Remove packaging and transport materials as well as any protective film from the interior.
- ▶ Clean the interior and accessories with lukewarm water or a mild soapy solution (water and washing-up liquid) and dry thoroughly.
- ▶ Check that all appliance door seals are completely dry and dry them if necessary.
- ▶ If the appliance was transported in a horizontal position, wait an hour before switching it on.

3 Appliance description

3.1 Structure



The direction in which the door opens can be changed. Please contact our Customer Services if necessary.

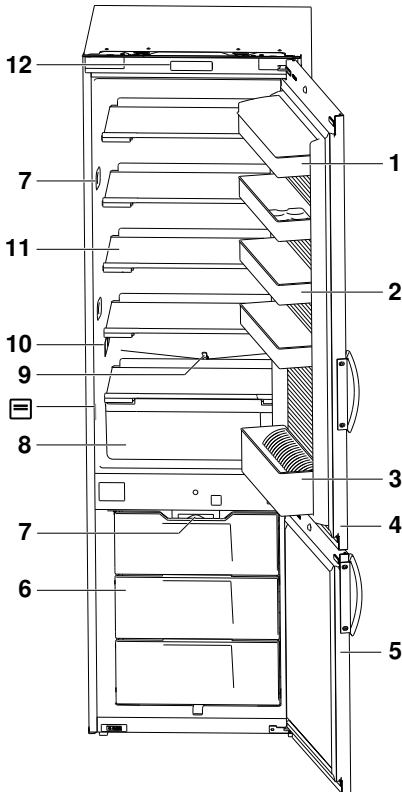

- 1 Door tray with cover
 - 2 Door trays
 - 3 Door tray with bottle holder * (bottles up to max. 1.5 litres)
 - 4 Refrigerator compartment door
 - 5 Freezer compartment door
 - 6 Freezer compartment drawer
 - 7 LED light *
 - 8 Vegetable drawer
 - 9 Defrost drainage channel
 - 10 Temperature sensor
 - 11 Shelves
 - 12 Operating and display elements
-  Identification plate with serial number (SN)

* Depending on model

3.2 Operating and display elements

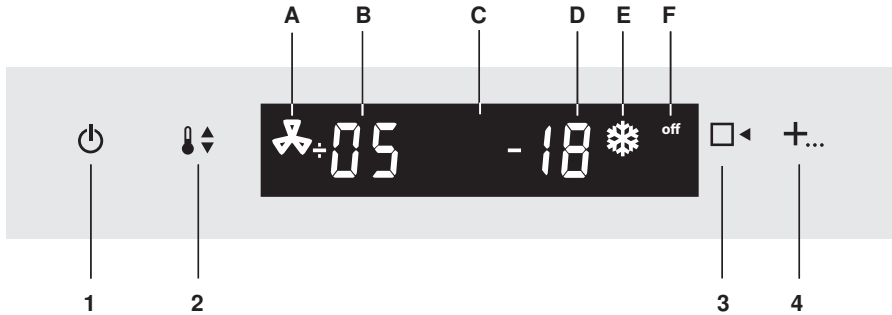

Display

- A Fast cooling
- B Refrigerator compartment temperature display
- C Display
- D Freezer compartment temperature display
- E Fast freezing
- F Appliance switched off

Buttons

- 1 ON/OFF
- 2 Temperature setting, confirming a setting
- 3 Preselection
- 4 Select special functions

4 Operation

Switching the appliance on



- ▶ Plug in the appliance at the mains.
 - «off» is shown on the right-hand side of the display for 30 seconds.
 - «off» is shown in the digital display for 30 seconds when the appliance door is opened or a button is pressed.
- ▶ Hold the  button depressed for 3 seconds.
 - The appliance is switched on.



An appliance that has been started up for the first time takes around 15 hours (with food inside) to reach its normal operating temperatures.

Setting the temperature in the cooling compartment



The temperature can be set between 2 °C and 9 °C.

- ▶ Depress the  button for 3 seconds.
 - The cooling compartment temperature display flashes in the display.
- ▶ Touch the  button repeatedly until the desired temperature flashes.
 - If no further settings are made after 5 seconds, the temperature set is accepted and the temperature display stops flashing.
 - The set temperature will be reached after a few hours.





The effective temperature may at times be different from the selected set value if the door is open for an extended period of time or if warm foods have been placed inside.



If the  button is pressed without having pressed the  button beforehand, a double acoustic signal is emitted.

Setting the temperature in the freezer compartment

The temperature can be set between -24 °C and -14 °C.

- ▶ Depress the  button for 3 seconds.
 - The cooling compartment temperature display flashes in the display.
- ▶ Touch the  button again.
 - The freezer compartment temperature display flashes in the display.
- ▶ Touch the  button repeatedly until the desired temperature flashes.
 - If no further settings are made after 5 seconds, the temperature set is accepted and the temperature display stops flashing.
 - The set temperature will be reached after a few hours.



The effective temperature may at times be different from the selected set value if the door is open for an extended period of time or if warm foods have been placed inside.

Switching the appliance off



- ▶ Hold the  button depressed for 3 seconds.
 - The appliance switches off.
 - «off» is shown in the digital display for 30 seconds.
 - «off» is shown in the digital display for 30 seconds when the appliance door is opened or a button is pressed.

If the appliance is being taken out of operation, e.g. for repair work or disposal:

- ▶ Remove the mains plug from the mains socket.
- ▶ When not in use for an extended period of time: Clear out, defrost and clean the appliance, and leave the cooling compartment door and freezer compartment door open.

5 Special functions

Switching the special function on

	Special function	Symbol	Remarks
▶ Hold the + ... button depressed for 3 seconds.	Fast cooling	 next to the temperature display for the refrigerator compartment.	
▶ Press the + ... button again.	Fast freezing	 next to the temperature display for the freezer compartment.	
▶ Press the + ... button again.	Holiday mode	<i>OF / OP / CL</i> in the temperature display for the refrigerator compartment.	Symbol type depends on model
▶ Press the + ... button again.	Sabbath mode	S in the temperature display for the refrigerator compartment.	S is illuminated for 30 seconds after activation

– The corresponding symbol flashes in the display.

- ▶ Press the  button.
 - The special function is activated.
 - The corresponding symbol is illuminated in the display.



Switching the special function off (early)

- ▶ Depress the **+**... button for 3 seconds.
- ▶ Press the **+**... button repeatedly until the desired special function is reached.
- ▶ Press the  button.
 - The special function is deactivated.

5.1 Fast cooling

The fast cooling function  allows large quantities of food, e.g. after a shopping trip, to be cooled more quickly. The temperature of the cooling compartment is controlled at 2 °C for 24 hours.

During the fast cooling process, the compressor operates at a higher cooling output, which increases the noise level to a level that is above the normal operating noise. The compressor output is increased until the temperature in the cooling compartment reaches the set temperature or the maximum time period has elapsed. The set temperature for the refrigerator compartment is reset to the previously set temperature after 24 hours.

 Immediately before putting food in the cooling compartment, switch on  to prevent food that is already in the refrigerator from warming up.

5.2 Fast freezing

The fast freezing function ❄️ allows large quantities of food, e.g. after a shopping trip, to be frozen more quickly. The function lowers the set temperature of the freezer compartment to the coldest set temperature (-24 °C) for 24 hours.

The compressor operates at a higher cooling output, which increases the noise level above the normal operating noise level. The compressor output is increased until the temperature in the freezer compartment reaches the set temperature or the maximum time period has elapsed. The set temperature for the freezer compartment is restored to the previous set temperature after 24 hours.

💡 Immediately prior to putting goods in the freezer, switch on ❄️ to prevent food that is already in the freezer from defrosting.

5.3 Holiday mode

The holiday mode function is dependent on the model.

When *OF* or *OP* is shown on the cooling compartment temperature display:

Only the freezer compartment operates when holiday mode is activated. This setting is retained until it is deactivated manually, even after a power failure.

⚠️ **Leave the cooling compartment door open to prevent odours from developing.**

5.4 Sabbath mode

In Sabbath mode, the lighting and displays are switched off for 28 hours.

6 Glass shelves and door trays

The height of the glass shelves in the refrigerator compartment and the door trays on the inside of the refrigerator compartment door can be adjusted.

💡 Short glass shelves make it possible to store tall containers in an upright position.

6.1 Positioning door trays

- ▶ Push the door tray up and remove it.
- ▶ Select the desired height.
- ▶ Hang the door tray in the openings in the door frame.
- ▶ Push the door tray down as far as it will go.

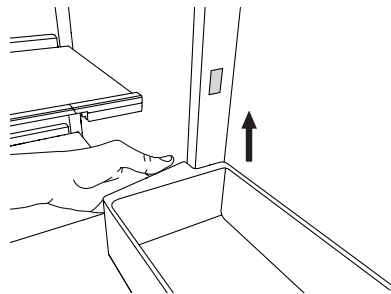

💡 The top door tray with the cover is not adjustable.

💡 When the appliance is new, it may require a little more effort to take out the door trays.

6.2 Positioning glass shelves

- ▶ On both sides, push the slide bar inwards and downwards.
 - The slide bar engages and stays in this position.
- ▶ Pull the glass shelf out of the rear guide and insert into desired position.
- ▶ To fix the glass shelf in place, turn the slide bar upwards and release it.
 - The slide bar engages.

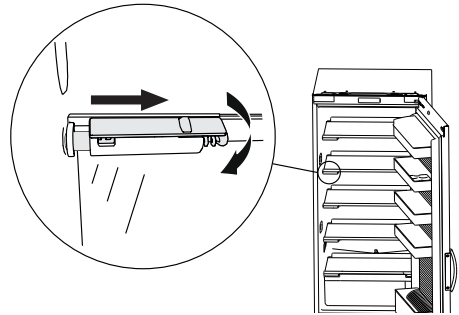

7 Tips and tricks

7.1 General information on using the appliance

- When closing an appliance door make sure that it forms a proper seal all the way round. The self-closing hinges help keep it closed: as the appliance doors close automatically if the opening angle is between 20–30°.
- The electronic controller defrosts the refrigerator compartment once a day. A visible layer of snow and ice on the rear wall of the refrigerator compartment is therefore normal.
- At high ambient temperatures, a significant amount of ice may form on the rear wall. This is normal: due to the high humidity, more water condenses in the appliance and ices up. Defrost the appliance manually if necessary.
- The food must not come into contact with the rear wall of the refrigerator compartment or it may freeze. Additionally, when defrosting the appliance, water may enter the refrigerator compartment.
- It can take several hours for food and beverages to cool down from room temperature to the temperature of the refrigerator compartment.
- Opening the door for long periods can cause a significant increase of the temperature in the compartments of the appliance.
- Make sure that food or food items on the glass shelves do not tip over when the appliance door is closed or prevent it from closing properly.
- Clean regularly surfaces that can come in contact with food and accessible drainage systems.
- Changing the temperature setting has no effect on the cooling rate. The fast cooling/freezing functions (depending on model) increase the cooling rate.
- Placing very warm or very cold items (e.g. warm, bottled sauces or frozen food for defrosting) directly in front of the temperature sensor can affect the temperature regulation of the appliance adversely: it may cool too little or too much.

7.2 Storing food

The example arrangement (from top to bottom) shows the zones and areas in the appliance that are generally suitable for certain food and food items.

On the glass shelves:

- Bakery products
- Ready meals
- Dairy products
- Meat, sausages and fish

In the vegetable drawer:

- Vegetables, fruit and salad

In the door trays:

- Butter and cheese
- Tubes and eggs
- Small tins
- Smaller bottles and Tetra Pak containers
- Large bottles (up to max. 1.5 litres)

In the freezer compartment:

- For freezing and storing food and making ice



7.3 Notes on refrigerating and freezing food

- Activate the fast cooling/freezing function (depending on model) before putting the food or food items in the appliance (e.g. before going shopping).
- High-protein and high-fat foods are delicate/perishable and have a relatively short storage life.
- Observe best-before and use-by dates.
- Wrap or cover food in the refrigerator compartment to prevent it from drying out and flavours from transferring.
- Transfer the contents of opened tins to sealable containers.
- Store raw meat and fish in suitable containers in the refrigerator, so that it is not in contact with or drip onto other food.
- Use the top drawer for freezing large quantities (see the identification plate for max. freezing capacity). If there is frozen food already in the top drawer, distribute it between the lower drawers.
- There is a risk that freezing fresh food could cause food that is already frozen to partially thaw. Freeze smaller quantities and avoid contact with food that has already been frozen.
- Depending on the product, the following packaging materials are suitable: freezer bags, aluminium foil or plastic boxes. Freezer burn can be avoided by making the food packaging as airtight as possible.

- Do not refreeze food once defrosted! Only after being prepared (through cooking or frying) can it be refrozen.
- Blanch vegetables before freezing. Aubergines, sweet peppers, courgettes, mushrooms, asparagus and herbs do not have to be blanched.
- The following products are not suitable for freezing: radishes, lettuces, cucumbers, raw unshelled eggs, boiled eggs, dairy products such as yogurt, cream cheese, curd cheese and mayonnaise.
- Do not defrost frozen food at room temperature or on the heating. Food defrosts slowly in the fridge. As a quick alternative, defrost in a microwave or steam cooker.

7.4 Notes on saving energy

- Leave the drawers, glass shelves and door trays as far as possible in the positions that they were in upon delivery. These ensure ideal temperature distribution and efficiency.
- Only open the appliance doors when necessary and keep them open for as short a time as possible.
- Allow hot or warm food to cool down before putting it in the appliance.
- Store food that releases moisture in closed containers or covered in the refrigerator compartment. Moisture can cause the rear wall of the refrigerator to ice up more quickly and reduce its cooling capacity.
- For ideal air circulation: Do not store food and food items too close to each other.

8 Care and maintenance

8.1 Cleaning

For hygienic storage of food and meals, the interior should always be kept clean.



Do not use any abrasive cleaning agents or scouring cloths to clean the appliance. Take care not to press too hard when cleaning the plastic surfaces.

Risk of causing damage to the appliance.

- ▶ Condensation can form in the vegetable drawers and on the glass shelves, depending on the kind and quantity of food being stored. Regularly wipe condensation away with a dry cloth.
- ▶ Clean the interior at regular intervals with a mild soapy solution and wipe dry thoroughly.
- ▶ Clean the operating and display elements just with a damp cloth.
- ▶ Regularly check the door seals and if dirty clean using a soft brush and clean water. Wipe dry.
- ▶ If the appliance is not to be used for a while, switch it off. Clear out, defrost and clean the appliance. Leave the refrigerator and freezer compartment doors open.



Ensure that no cleaning water runs through the defrost drainage channel into the evaporation tray.

Risk of causing damage to the appliance.

8.2 Defrosting

Defrosting the cooling compartment

The cooling compartment defrosts once a day automatically.

During defrosting, the temperature inside the cooling compartment increases so that the ice on the rear wall melts. The water created when the ice melts collects in the defrost channel, flows through the drain hole and evaporates outside the appliance in the evaporation tray.

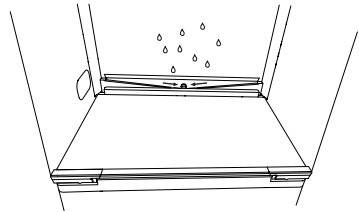

When defrosting is complete, the temperature is lowered back down to the set target temperature.



Keep the collection channel and the drain pipe clean so that the water can flow freely.

- ▶ Clean the defrost drainage channel with the green cleaner that is in it with an up-and-down and circular motion.

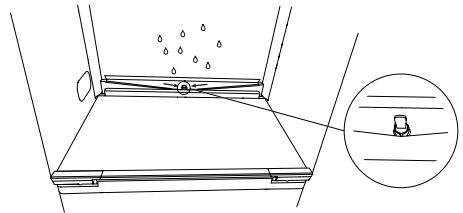

If milk has been spilt accidentally and has ended up in the defrost drainage channel:

- ▶ Push some kitchen towel into the drain hole and try to absorb as much liquid as possible.
- ▶ If more than 1 dl has flowed into the defrost drainage channel and/or a strong odour develops after a while: call Customer Services.



If any foreign objects get into the defrost drainage channel:

- ▶ Carefully insert a flexible plastic object (such as a cable tie) into the drain hole and try to remove any foreign objects.
- ▶ Do not use hard or sharp objects, or the defrost drainage channel and surrounding components could get damaged.

Defrosting the freezer compartment

A thick layer of ice will prevent the cold from being transferred to the frozen food. Therefore, the freezer compartment should be defrosted if a lot of ice has formed. When defrosting, keep frozen food as cold and insulated as possible, e.g. by wrapping it in newspaper.



Do not use pointed objects to remove ice or food that has frozen on solid. Do not use electrical heaters or naked flames for defrosting.

- ▶ Switch the appliance «off» using the  button.
- ▶ Remove the defrost drainage channel and place the drain tray underneath.
- ▶ Leave the freezer compartment door open.

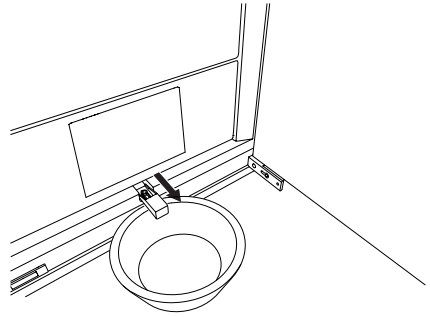

- ▶ After defrosting, clean the interior and dry thoroughly.
- ▶ Start the appliance again using the  button.

8.3 Changing the LED lighting



Use original LED lights from the manufacturer only.

- ▶ Disconnect the power supply to the appliance: Pull out the mains plug or switch off the fuse.

Cooling compartment

- ▶ Click off the LED light cover.

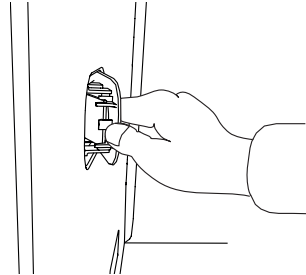

- ▶ Disconnect the plug connection 1 for the LED light.

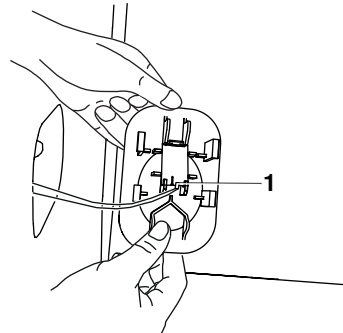

- ▶ Reverse this procedure to insert the new LED light.

Freezer compartment *

* Depending on model

- ▶ Simultaneously release the locking device on the underside on both sides with the index fingers and then pull the upper edge of the transparent cover downwards.

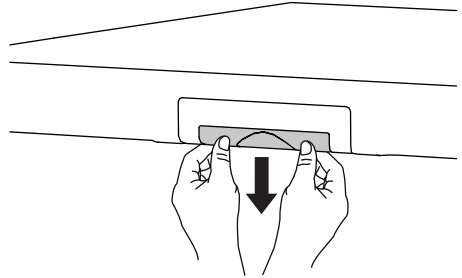

- ▶ Press the locking device on the lower edge of the LED light backwards and click it out.

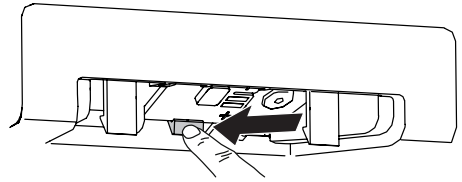

- ▶ Pull out the lateral plug connection.

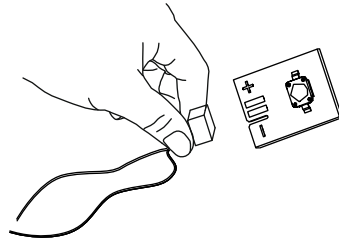

- ▶ Reverse this procedure to insert the new LED light.

9 Noises and alarms

9.1 Operating noise

The appliance can make various noises during operation. Although the appliance is noise-optimized, some noise cannot be eliminated completely. This noise depends on the size of the appliance, how it is installed and the cooling requirements (e.g. fast cooling), the ambient temperature and the installation conditions. Operating noises are particularly audible immediately after switching on the compressor; however, these noises become quieter as the appliance runs.

Unusual noises are often caused by improper installation. The appliance must be installed on a level and stable surface. In open kitchens or in the case of appliances installed in partitioned areas, normal operating noises may seem louder. This is not a fault but rather an effect of the design/architecture.

Keyword	Cause	Remarks
Buzzing	Cooling unit	Normal operating noise made by the cooling unit; volume depends on the size of the appliance and the load-dependent speed of the compressor motor.
Gurgling, bubbling, hissing	Cooling circuit	Normal operating noise caused by the flow of refrigerant through the cold circuit.
Fizzling	Cooling circuit	Normal operating noise caused by the injection of refrigerant into the evaporator.
Rattling	Glass shelves, baskets, door trays, contents, etc.	Arrange the parts in the interior so that they are fixed in place and are not touching.
Creaking	Housing	Normal, temperature-dependent stress-strain of the materials, e.g. plastics, insulation.
Clicking	Valve	Normal switching noise of the switching valve.

9.2 Warning and alarm signals

Warnings when the appliance doors are open

If the cooling compartment or freezer compartment door is open for several minutes, the following alarm signals occur:

After 2 minutes	LEDs flash every 15 seconds.
After 3 minutes	LEDs flash every 5 seconds.
After 4 minutes	LEDs flash rhythmically every second.
After 10 minutes	An acoustic alarm sounds for 3 minutes. The acoustic alarm repeats every 30 minutes.

Temperature alarm

An acoustic signal sounds if the cooling compartment temperature rises 10 °C above the selected temperature value or if the freezer compartment temperature is more than -9 °C.

Cancelling alarm

- ▶ Touch any button.
- ▶ Resolve problem, see Trouble-shooting.



When the Sabbath mode is activated, there are no visual warning signals.

10 Trouble-shooting

This section lists faults that can be solved simply by following the instructions given. If the fault cannot be remedied, please contact Customer Services. Before contacting Customer Services:

- ▶ please note down the serial number (SN), which is shown on the identification plate, as well as
- ▶ the sequence of events that led to the fault.

Malfunction	Possible cause	Solution
Appliance is not working.	▪ An interruption in the power supply.	▶ Check the power supply. ▶ Change the fuse. ▶ Reset the automatic circuit breaker.
	▪ The fuse or circuit breaker keeps blowing.	▶ Contact Customer Services.
	▪ Appliance is faulty.	▶ Contact Customer Services.
Illumination is not working.	▪ LED light bulb is defective.	▶ Replace the LED light bulb.
Illumination is flashing	▪ Appliance door has been standing open for more than 2 minutes. ▪ Appliance door was not closed properly.	▶ Close the appliance door.

Malfunction	Possible cause	Solution
Error display F₋	▪ Various situations can lead to an «F» message.	▶ Contact Customer Services.
Error display F!	▪ Temperature sensor in the refrigerator compartment is defective.	▶ Contact Customer Services. – The appliance enters the emergency mode. The refrigerator compartment is cooled at the same output level as before the temperature sensor malfunction.

Malfunction	Possible cause	Solution
Error display F²	▪ Temperature sensor in the freezer compartment is defective.	▶ Contact Customer Services. – The appliance enters the emergency mode. The freezer compartment is cooled at the same output level as before the temperature sensor malfunction.

Malfunction	Possible cause	Solution
Temperature display is flashing.	<ul style="list-style-type: none"> ▪ The refrigerator compartment temperature is 10 °C higher than the set temperature or the freezer compartment temperature is above -9 °C. 	<ul style="list-style-type: none"> ▶ Do not place warm foods right next to the temperature sensor. ▶ If there is no warm food in the appliance: call Customer Services.
	<ul style="list-style-type: none"> ▪ There has been a power failure. The flashing temperature display shows the temperature when the appliance is put back into service. 	<ul style="list-style-type: none"> ▶ Touch any button. <ul style="list-style-type: none"> – The set temperature is shown in the temperature display. ▶ Check any refrigerated or frozen food and discard if spoiled.

11 Technical data

Product data

- ▶ See the identification plate, energy label and www.vzug.com.

External dimensions

- ▶ See installation instructions

Electrical connection

- ▶ See identification plate

11.1 Food safety contact

Material	PTFE	Rubber, silicone	PS, PPS, PP, PBT, AS	Glass	Stainless steel
GB 4806.1-2016			X	X	
GB 4806.5-2016				X	
GB 4806.6-2016			X		
GB 4806.7-2016			X		

11.2 Temperature measurement

The refrigerator and freezer compartment temperature are measured in accordance with an internationally recognized standard. Own measurements can be imprecise and are not suitable for checking the accuracy of the temperature.

11.3 Note for testing institutes

If freezing the maximum quantity of food (see the identification plate), the top drawer must be used. This requires the special  function be activated immediately before storing the food.

12 Disposal

12.1 Packaging



Never allow children to play with packaging material due to the danger of injury or suffocation. Store the packaging material in a safe location or dispose of it in an environmentally-friendly way.

12.2 Safety

Render the appliance unusable to prevent accidents caused by improper use (e.g. through children playing):

- ▶ Disconnect the appliance from the mains. With a fixed appliance, this is to be carried out by a qualified electrician. Then cut the mains cable off flush with the appliance.

12.3 Disposal



-  The «crossed out wheeled bin» symbol requires the separate collection of waste electrical and electronic equipment (WEEE). Such equipment can contain hazardous, environmentally harmful materials.
- These appliances are to be handed over to a designated collection point for the recycling of electrical and electronic equipment and must not be disposed of with unsorted household waste. And in this way, you will be helping to protect resources and the environment.
- For more information, please contact the local authorities.

13 Index

A		
Alarm.....	19	
Appliance disposal.....	22	
Appliance installation.....	5	
C		
Care and maintenance.....	15	
Cleaning.....	15	
Construction.....	8	
D		
Defrost drainage channel.....	16	
Defrosting.....	16	
Disposal.....	22	
Door trays.....	12	
E		
Electrical connection.....	21	
Error display		
Appliance is not working.....	20	
F.....	20	
F1.....	20	
F2.....	21	
Illumination is flashing.....	20	
Illumination is not working.....	20	
Temperature display is flashing.....	21	
F		
Fast cooling.....	11	
Fast freezing.....	12	
Food safety test.....	21	
Freezer compartment temperature display		
.....	9, 28	
G		
Glass shelves.....	13	
H		
Holiday mode.....	12	
I		
Identification plate.....	8, 21, 27	
Initial set-up.....	5, 8	
Instructions for use.....	5	
M		
Model designation.....	2	
Model number.....	2	
N		
Noises.....	18	
Notes.....	24	
O		
ON/OFF.....	9, 28	
Operating and display elements.....	9	
Operating the appliance.....	9	
P		
Preselection.....	9, 28	
Product data.....	21	
R		
Refrigerator compartment temperature display		
.....	9, 28	
S		
Sabbath mode.....	12	
Safety precautions		
General.....	4	
Safety warnings		
Appliance installation.....	5	
Appliance-specific.....	5	
Correct use.....	6	
Service & Support.....	27	
Setting temperature		
Cooling compartment.....	10	
Setting the temperature		
Freezer compartment.....	10	
Special functions.....	9, 28	
Switching on.....	11	
Switching appliance on.....	9	
Switching on.....	9	
Symbols.....	4	
T		
Technical data.....	21	
Technical questions.....	27	
Temperature measurement.....	21	
Temperature setting.....	9, 28	
Testing institutes.....	21	
Tips.....	13	
Trouble-shooting.....	20	
Type.....	2	
U		
Using for the first time.....	5, 8	
V		
Validity.....	2	
W		
Warning signal.....	19	
Warranty extensions.....	27	

Notes

14 Service & Support



The «Trouble-shooting» section gives you valuable tips on how to deal with minor malfunctions yourself, saving you the time and trouble of calling out a service technician and any cost that goes along with it.

Information on the V-ZUG warranty can be found at www.vzug.com →Service →Warranty information. Please read this information carefully.

Please register your appliance straightaway online at www.vzug.com →Service →Warranty registration. This will allow you to take advantage of the best possible support in the event of a fault in the appliance during the guarantee period. You will require the serial number (SN) and appliance designation to register your appliance. You will find them on the identification plate of your appliance.

My appliance information:

SN: _____ **Appliance:** _____

Please have this appliance information to hand when contacting V-ZUG. Thank you.

The identification plate  is located to the left of the vegetable drawer.

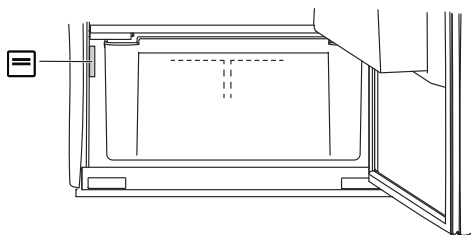

Your repair order

At www.vzug.com →Service→Service number you will find the telephone number of your nearest V-ZUG service centre.

Technical questions, accessories, warranty extensions

V-ZUG is happy to help you with any general administrative or technical queries, to take your orders for accessories and spare parts and to inform you about our progressive service agreements.

Quick instructions

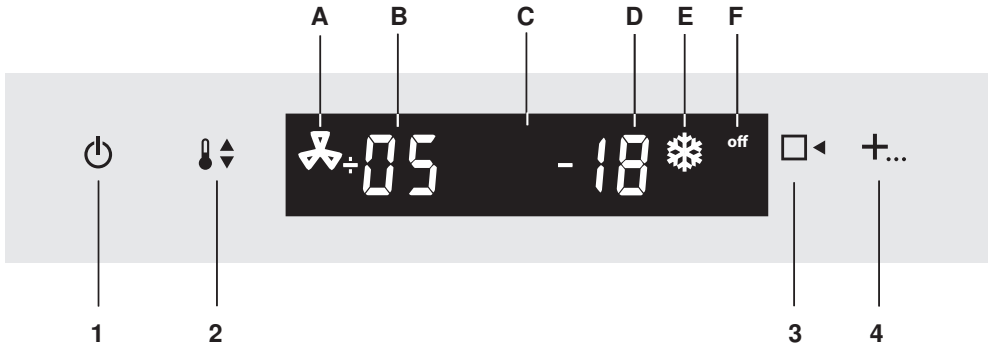

Display

- A Fast cooling
- B Refrigerator compartment temperature display
- C Display
- D Freezer compartment temperature display
- E Fast freezing
- F Appliance switched off

Buttons

- 1 ON/OFF
- 2 Temperature setting, confirming a setting
- 3 Preselection
- 4 Select special functions



10179509



J51045352-R05

