

Washing machine

Adora SLQ

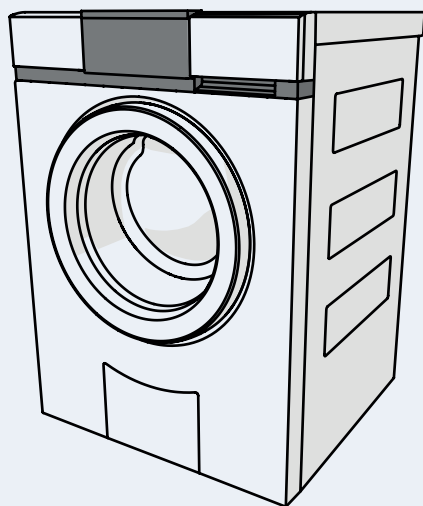

Operating instructions

Thank you for choosing to buy one of our products. Your appliance is made to high standards and is easy to use. Nevertheless, please take the time to read these operating instructions in order to familiarize yourself with the appliance and get the best use out of it.

Please follow the safety precautions.

Modifications

Text, diagrams and data correspond to the technical standard of the appliance at the time these operating instructions went to press. The right to make technical modifications for the purpose of the further development of the appliance is reserved.

Validity

The product family (model number) corresponds to the first alphanumeric on the identification plate. These operating instructions apply to:

Model	Type	Product family
Adora SLQ	WA-SLQ	11006

Variations depending on the model are noted in the text.

Colour operating instructions can be downloaded from the internet from www.vzug.com

Contents

1	Safety precautions	6
1.1	Symbols used	6
1.2	General safety precautions	7
1.3	Appliance-specific safety precautions	9
1.4	Instructions for use	10
2	Disposal	13
3	Using for the first time	14
3.1	Where is the identification plate?	14
4	Appliance description	15
4.1	Appliance overview	15
4.2	Appliance construction	16
4.3	Operating and display elements	17
5	Programme overview	19
5.1	Main wash programmes	19
5.2	2 programmes for normally soiled cotton load	21
5.3	Extra programmes	21
5.4	Further fabric types	22
5.5	Additional programmes	25
5.6	Bio and soap wash	27
5.7	Separate rinsing / Separate spinning	28
5.8	Additional functions	29
5.9	Favourites	30
6	User settings	32
6.1	Adjusting user settings	32
6.2	Language	33
6.3	Time	33
6.4	Spin speed	33
6.5	AquaPlus	34
6.6	Degree of soiling	34
6.7	Automatic door opener	35
6.8	Childproof lock	35
6.9	Hygiene recommendation	35
6.10	Soft water	36
6.11	Multi-component detergent	36
6.12	Loosening up the washing	36

6.13	Brightness	36
6.14	Button tone	37
6.15	Background image	37
6.16	Silent	37
6.17	Restoring factory settings	37
7	Washing	38
7.1	Preparing the appliance	38
7.2	Loading the appliance	39
7.3	Adding washing detergent	40
7.4	Selecting a programme	43
7.5	Selecting whites and coloureds programmes	44
7.6	Selecting another main programme	45
7.7	Selecting programmes for normally soiled cotton load	46
7.8	Selecting additional programmes	47
7.9	Opening the appliance door during operation	50
7.10	Changing selection	51
7.11	Programme selection with childproof lock activated	52
7.12	End of programme	53
7.13	At the end of the wash day	54
8	Care and maintenance	55
8.1	Cleaning the detergent dispenser drawer	55
8.2	Cleaning the water inlet filter	56
8.3	Emergency draining	57
8.4	Cleaning the foreign body trap	58
9	Trouble-shooting	59
9.1	What to do if	59
9.2	Opening the appliance door in the event of a power failure	68
10	Washing tips	69
10.1	Fabric care symbols	69
10.2	Washing detergent	69
10.3	General tips	69
10.4	Net curtains	70
10.5	Saving energy and water	71
10.6	Unsatisfactory wash results	72

11 Spare parts	76
12 Technical data	77
12.1 Dimensions	77
12.2 Plumbing in	77
12.3 Electrical connection	77
12.4 Spin speed	77
12.5 Consumption data	78
12.6 Note for testing institutes	80
12.7 VAS Vibration Absorbing System	80
12.8 Water and energy economy	81
12.9 Automatic energy-saving stand-by	81
13 Index	82
14 Repair service	87

1 Safety precautions

1.1 Symbols used



Denotes important safety precautions.

Failure to observe said precautions can result in injury or in damage to the appliance or fittings!



Information and precautions that should be observed.



Information on disposal



Information about the operating instructions

- ▶ Indicates step-by-step instructions.
 - Describes how the appliance reacts to the steps taken.
- Indicates a list.

1.2 General safety precautions



- Read the operating instructions before using the appliance for the first time!



- This appliance can be used by children aged 8 and above and by persons with reduced physical, sensory or mental capabilities, or lack of experience and/or knowledge, provided they are supervised or have been instructed on the safe use of the appliance and have understood the hazards involved. Children shall not play with the appliance. Cleaning and user maintenance shall not be undertaken by children without supervision.

- If an appliance is not equipped with a mains cable and a plug or other means for disconnecting from the mains with a contact opening on each pole complying with the conditions of overvoltage category III for full isolation, an isolating device must be incorporated into the permanently installed electrical installation in accordance with the installation regulations.
- If the mains cable of this appliance is damaged, it must be replaced by the manufacturer or its Customer Services or a similarly qualified person in order to avoid hazard.

1.3 Appliance-specific safety precautions



- Children under 3 years of age must be kept away unless constantly supervised.
- The appliance has a maximum dry load capacity of 8 kg.

CAUTION

- If this appliance is supplied from a cord extension set or electrical portable outlet device, the cord extension set or electrical portable outlet device must be positioned so that it is not subject to splashing or ingress of moisture.

1.4 Instructions for use

Before using for the first time

- The appliance must be installed and connected to the electricity supply in accordance with the separate installation instructions. Have a qualified fitter/ electrician carry out the necessary work.
- Ensure access to the place of disconnection (e.g. socket outlet, wall switch, fuse) and the water tap.
- The transportation lock must be removed. Failure to remove the transportation locks can result in damage to the appliance or apartment or laundry room fittings.

Correct use

- The appliance is suitable for washing home textiles with water and regular washing machine detergent. It is designed for use in the home and for the above-mentioned purpose only. No liability is assumed for any damage caused by improper or incorrect use.
- Any repairs, modifications or manipulations to the appliance, especially any electrically live parts, may only be carried out by the manufacturer, its Customer Services or a similarly qualified person. Repairs if carried out incorrectly could cause serious injury or damage to the appliance and fittings as well as affect the functioning of the appliance. If the appliance is not working properly or in case of a repair order, follow the instructions given in the 'Repair service' section. If necessary, please contact our Customer Services.
- Use original spare parts only.

Note on use

- If the appliance is not operating properly, disconnect it from the power supply immediately.
- To protect your washing, follow the fabric care symbols and the hints and advice in the 'Washing tips' section.

Caution: Burns hazard!

- Textiles that have been cleaned, treated or soaked with flammable chemicals, detergents or solvents such as benzene, alcohol, stain remover, oil, paint, wax, etc. are not to be washed in the appliance. Fire or explosion hazard! Wash materials containing such substances first by hand with water or allow the solvent to evaporate completely.

Caution: Risk of injury!



- Ensure the washing drum has stopped moving before reaching inside. Do not touch the washing drum while it is still in motion – risk of serious injury!
- Disconnect the appliance from the mains before carrying out maintenance work.

Caution: Risk to life!

- Packaging material, e.g. plastic film and polystyrene, can be dangerous for children. Danger of suffocation! Keep packaging material away from children.

How to avoid damaging the appliance

- Close the appliance door carefully.
- Before closing the appliance door and starting a programme, ensure that there are no foreign objects or pets in the washing drum, detergent dispenser drawer or around the foreign body trap. Foreign objects such as coins, nails, paper clips, etc. can damage parts of the appliance, as well as the washing.
- During longer periods of absence, turn off the water tap before switching off the power by pulling out the mains plug. Never pull the mains plug out by the cable. Please note: the built-in overflow protection is rendered inactive when the power is switched off.
- When cleaning the appliance make sure no water gets inside it. Use a moderately damp cloth. Do not spray the outside or the inside of the appliance with water. If water gets inside the appliance, it will cause damage.
- Textiles with metal reinforcements are not to be washed in the appliance (risk of damage).
- Trainers, diving suits, rucksacks, carpets, etc. are not to be washed in the appliance.

2 Disposal

Packaging

- All packaging materials (cardboard, plastic film (PE) and polystyrene (EPS)) are marked and should, if possible, be collected for recycling and disposed of in an environmentally friendly way.

Disconnection

- Disconnect the appliance from the mains. With a fixed appliance, this is to be carried out by a qualified electrician!

Safety

- Disable the appliance to prevent accidents caused by improper use, especially through children playing.
- Pull the plug out of the mains socket or have the appliance disconnected from the mains by an electrician. Then cut the mains cable off flush with the appliance.
- Remove or disable the lock on the appliance door.

Disposal

- The old appliance should not be discarded as worthless rubbish. If disposed of correctly, the raw materials can be recovered for recycling.



- The  symbol on the identification plate warns that the appliance may not be disposed of in normal household waste.
- The appliance must be disposed of in accordance with local regulations on waste disposal. For more information on the handling, disposal and recycling of the product, please contact the local authorities, the local recycling facilities for household waste or the retailer from whom you purchased the appliance.

3 Using for the first time

The appliance must be installed and connected to the electricity supply in accordance with the separate installation instructions. Have a qualified fitter/ electrician carry out the necessary work.



The appliance was tested with water before being shipped. There may therefore still be traces of water left in the appliance.

Transport lock



Before using the appliance for the first time, the transportation lock must be removed (3 screws with washers at the back of the appliance), in order to avoid damage to the appliance.

Running the first wash cycle without any washing

Run an empty wash cycle to remove any residues from the manufacturing process.

- ▶ Add a little washing detergent to compartment II.
- ▶ Select coloureds 60 °C.

3.1 Where is the identification plate?

- 1 Identification plate with serial number (FN)

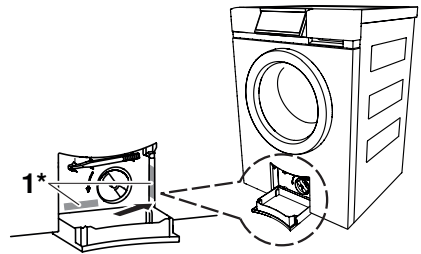

* Depending on the serial number (FN)

Note down the serial number (FN) of your appliance on the back page of these operating instructions.

4 Appliance description

4.1 Appliance overview

- Load capacity: 8 kg dry washing
- Programmes for 14 different types of textiles
- 2 programmes for normally soiled cotton load
- 4 extra programmes
- 6 favourite programmes
- Additional programmes
 - Eco
 - Sprint
 - Easy care
 - Pre-wash
 - Steam anti-crease
 - Spin-speed setting including stop after rinsing
 - Programmes for lightly to heavily soiled washing
 - Anti-mite
 - AquaPlus including skin protection
 - Delayed start
 - Soaking
 - Soap wash
 - Bio wash
- Additional functions
- Sensors for optimizing the wash cycle
- Automatic energy-saving stand-by
- TouchDisplay
- Automatic door opener
- Language selection
- Childproof lock
- Aquastop with anti-leak protection

4.2 Appliance construction



The appliance door can be set to open to the left or to the right. Our Customer Services can make the necessary adjustments to the appliance.

- 1 Operating and display elements (pivoting operating panel)
- 2 Detergent dispenser drawer
- 3 Appliance door
- 4 Drain tray
- 5 Foreign body trap
- 6 Emergency door release tool
- 7 Emergency door release
- 8 Identification plate / Serial number (FN)

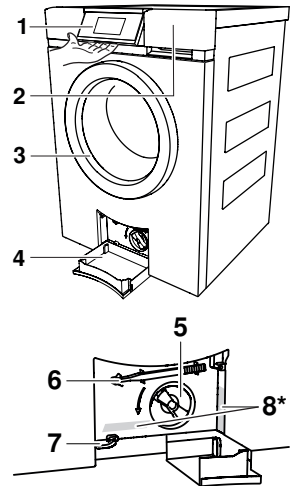

* Depending on the serial number (FN)

Detergent dispenser drawer

- 9 Pre-wash detergent, compartment I
- 10 Main wash detergent, compartment II
- 11 Liquid detergent flap
- 12 Siphon for fabric conditioner (softener)
- 13 Fabric conditioner (softener), compartment 

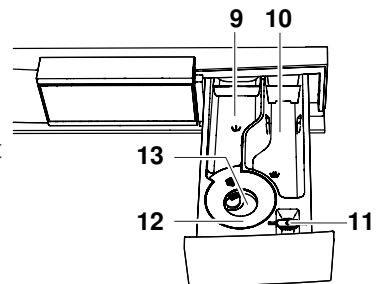

4.3 Operating and display elements

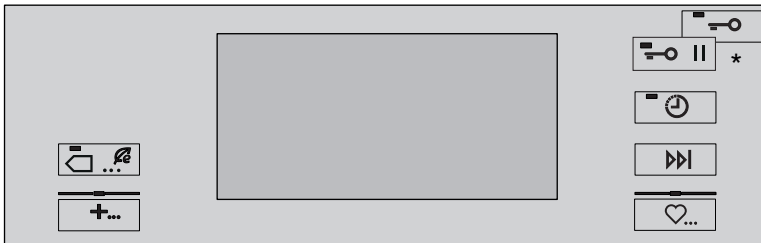

TouchDisplay

All available functions are displayed on the TouchDisplay and can be selected directly by pressing the corresponding symbol or text

- Programme name with duration
- Programme end time
- Programme progress with time remaining
- Additional functions
- Delayed start
- User settings
- Hints and trouble-shooting
- Further information



Programmes for normally soiled cotton load

- 40 °C Coloureds normal
- 10 °C Coloureds normal



Extra programmes

- Steam anti-crease
- Proofing
- Appliance hygiene
- Spinning



Favourites

Additional function/Additional programmes



Eco



Delayed start



Fast forward /
End of programme



* Pause / Door opener or Door opener

* Depending on the serial number (FN)

Button state

The buttons arranged on the TouchDisplay have three different operating states.

Symbol	Background	
Bright	Dark	Selectable function Programme or function can be selected.
Bright	Blue	Function selected/changed Programme or function is active.
Dark	Dark	Non-selectable function Programme or function is switched off.

Indicator lights

Certain of the buttons to the left and right of the TouchDisplay are equipped with an indicator light.



Indicator light flashes

Programme or function can be selected.



Indicator light is illuminated

Programme or function is active.



Indicator light is dark

Programme or function is switched off.

5 Programme overview

5.1 Main wash programmes



To select the right programme, follow the fabric care symbols on the labels of the wash items, e.g. .

95

Whites 95 °C

1–8 kg

White cottons, linens with the  fabric care symbol e.g. bed and table linen, towels, white or colour-fast underwear.

70

Coloureds 70 °C

1–8 kg

Energy-saving programme for coloured cottons with the  fabric care label.

60

Coloureds 60 °C

1–8 kg

Coloured cottons with the  fabric care symbol e.g. bright blouses, overalls, shirts, bed linen.

40

Coloureds 40 °C





1–8 kg

Coloured cottons and mixed washing with the  fabric care symbol e.g. coloured sweatshirts, t-shirts.





30 **Coloureds 30 °C** 1–8 kg

Coloured cottons and mixed fabrics with the  fabric care symbol e.g. t-shirts.



20 **Coloureds 20 °C** 1–8 kg

Energy-saving programme for lightly soiled textiles with fabric care symbols , ,  or .

cold **Coloureds cold** 1–8 kg

Refresh programme without heat. Suitable for washing new textiles with the , ,  or  fabric care label for the first time.

 **Favourites**

Six programmes that can be freely put together and saved 1–6.

5.2 2 programmes for normally soiled cotton load



40 °C Coloureds normal

40

The recommended programme for washing normally soiled cottons at rated load capacity.



10 °C Coloureds normal

cold

The programme with the lowest possible temperature setting for washing cottons. It corresponds to the 40 °C Coloureds normal programme without the water being heated. This programme has the same water level as the 40 °C Coloureds normal programme.

5.3 Extra programmes



Steam anti-crease

1–1.5 kg

Dry, creased washing that can be washed at min. 40°C is partially uncreased and made damp, ready to iron.



Proofing

1–3 kg

For starching or proofing fabrics. The starching or proofing agent can be added to the fabric conditioner compartment .



Appliance hygiene

0 kg

Without any washing. A small amount of water is heated up to around 80 °C and the steam produced sharply reduces the germ count.



Spinning

1–8 kg

5.4 Further fabric types

Shirts

Maximum 7 shirts/blouses

Programme is optimized for minimizing creasing. Programme contains steam anti-crease. Select temperature according to fabric care symbol.

Woollens

1–2.5 kg

Gentle wash for woollens and other delicates. Only for woollens with a felt-free finish and labelled as «machine washable».

Hand wash

1–2 kg

Very gentle wash for items labelled with the  fabric care symbol.

Down

1 item of washing, max. 1 kg

Programme is optimized for the particular wetting characteristics of down fabrics.

Short spin at the beginning of the programme to get rid of any air in down textiles.

Intermediate spinning for optimal removal of water. Select temperature according to fabric care symbol.



Add the detergent to the detergent dispenser drawer. Do not use a dosing ball.

Outdoor garments

1–3 kg

Programme for waterproof and breathable clothing. Higher water level during washing and spinning. Intermediate spinning for optimal removal of water. Select temperature according to fabric care symbol.

Silks

1–1.5 kg

Programme is optimized for delicate silk articles. Spin speed is reduced to minimize creasing. Select temperature according to fabric care symbol.

Underwear

1–3 kg

Very gentle programme for washing delicates, such as underwear, with the  fabric care label. The intermediate spin is significantly reduced and the final spin has a lower spin speed. Select temperature according to fabric care symbol.

Baby garments

1–5 kg

Very thorough rinsing for the protection of sensitive baby skin. If a  temperature is selected, the programme contains a pre-wash. Select temperature according to fabric care symbol.

Denim

1–4 kg

Optimized for colour run from denim. Select temperature according to fabric care symbol.

WetClean



1–1.5 kg

For all fabrics labelled as washable. Most gentle treatment possible through applying a gentle rocking motion and a fine spray of water.

Net curtains

1–2 kg

Reduced washing action for very gentle treatment. Higher water level during washing and spinning. The washing remains lying in the water after the final rinse (stop after rinsing).

- ▶ Press the  button 1×.
 - Start draining with spinning at 400 rpm.
- ▶ Press the  button 2×.
 - Start draining without spinning.

Select temperature according to fabric care symbol.

Black garments

1–4 kg

Rinsing is optimized through a higher water level and extended rinsing. Select temperature according to fabric care symbol.

Black hand wash garments

1–2 kg

Very gentle wash for items labelled with the  fabric care symbol. Rinsing is optimized through a higher water level and extended rinsing time. Select temperature according to fabric care symbol.

5.5 Additional programmes

Eco



Large energy savings due to reduced wash temperature. The extended washing time ensures the washing performance is maintained.

- Programme duration extended: 25–60 minutes
- Energy saving depending on programme: 10–40 %

Water savings due to reduced amount of water for rinsing. The extended rinsing time ensures the rinsing performance is maintained.

- Water saving: 10-20 %

Sprint



Short programme for lightly soiled washing

- Programme duration for 2.5 kg wash load

20 +  : 26 minutes

30 +  : 28 minutes

40 +  : 29 minutes

60 +  : 39 minutes

- 2 instead of 3 rinsing cycles



Add a small quantity of washing detergent.

A large washing load or too much washing detergent can significantly lengthen the programme duration.

Easy care



For washing requiring very gentle treatment

- Reduced washing action
- Higher water level during washing and rinsing
- Reduced spin speed: 800 rpm
- Optimum wash load: max. 3.5 kg

Pre-wash





Suitable for heavily soiled washing

- Programme duration extended: about 15 minutes

Steam anti-crease



The steam finish at the end of the programme significantly reduces creasing in the washing. Recommended for items that crease easily, e.g. shirts and blouses.

- The washing is warm and should be hung up immediately to dry – for easy ironing – or tumble dried.
- To avoid renewed creasing at the end of the programme, the washing is loosened up for an extended period (min. 60 minutes). The washing can be unloaded at any time.
 - Press the  or  button and unload the washing.
- Programme duration extended: about 20 minutes
- Limited spin speed: max. 1000 rpm
- Optimum wash load: max. 2 kg

Degree of soiling



Adjustment to the degree of soiling of the washing



«Soiling light»

- Suitable for lightly soiled washing



«Soiling medium»

- Wash time extended: 25–80 minutes



«Soiling heavy»

- Extended wash time
- Higher water level during washing
- Additional rinsing cycle



«Soaking»

- ▶ Press the corresponding button in the TouchDisplay to set the soaking time (0.5–6 hours)

Anti-mite



Can be selected with ,  and  only.

- Suitable for individuals with an allergy to mites
 - The main wash is extended and intensified at the temperature set. The mites are killed and the allergens are rinsed out thoroughly.

AquaPlus



There are 5 different settings for rinsing intensity.



«Standard»

- Normal water level



«More water»

- The water level is increased by around 1–3 cm during the main wash and each rinse cycle.



«+1 rinse»

- An extra rinse cycle is added to each programme.



«More water +1 rinse»

- An extra rinse cycle is added to each programme and the water level is also increased by around 1–3 cm during the main wash and each rinse cycle.



«Skin protection»

- Two extra rinse cycles are added to each programme and the water level is also increased by about 5 cm during each rinse cycle. This function is particularly suitable for people with sensitive skin or with a suspected allergy to washing detergent.

5.6 Bio and soap wash

Bio wash (alkaline detergent + bleach)

The programme sequence is adapted for the use of multi-component detergents (alkaline detergent + bleach). First the alkaline detergent with softener (compartment **II**) is added to the wash and the suds are heated up to 40 °C. Then after around 6 minutes the bleach (compartment **I**) is added.

Soap wash (softener + soap detergent)

The programme sequence is adapted for the use of multi-component detergents (softener + soap detergent). The softener (compartment **I**) and the soap detergent (compartment **II**) are added to the wash one after the other.

Selecting bio or soap detergent



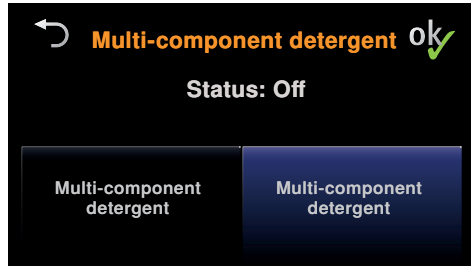

- ▶ In user settings, set the «multi-component detergent» setting to status ON and confirm with **ok**.

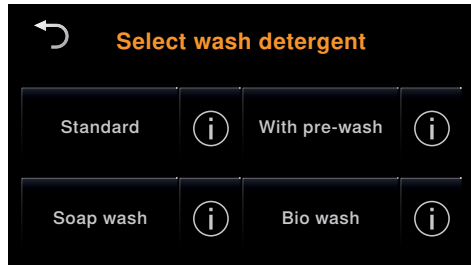







- ▶ Select main programme.
- ▶ Press the  button.
 - The display shown adjacent appears.
- ▶ Press the desired detergent type.



5.7 Separate rinsing / Separate spinning

-  It is possible to skip parts of the programme selected.
 - ▶ Select main programme according to fabric care labels.
 - ▶ Press the  button 1x.
 - Rinsing and final spin are selected.
 - ▶ Press the  button 2x.
 - Final rinse / Conditioning and final spin are selected.
 - ▶ Press the  button 3x.
 - Separate final spin is selected.

5.8 Additional functions

Function/Symbol	Uses
Spin speed 	The spin speed can be changed in steps of 200 rpm (1200, 1000, 800, 600, 400 rpm, stop after rinsing, 1600, 1400 rpm). Delicates can thus be spun at a lower spin speed. However, this increases the drying time (greater energy consumption for tumble drying).
Delayed start 	Take advantage of cheap-rate electricity (setting range of up to 24 hours). When the time set is reached, the programme starts automatically.
Fast forward / End of programme 	Press the  button to skip individual parts of a programme at any time during the programme sequence.
Pause / Door opener* 	Pressing the  button 1× when a programme is running will cause the programme to pause. Pressing the  button again will cause the appliance door to open provided the appliance is in a state (depending on the water level, temperature, speed) that allows this. Press the «Continue programme» button in the TouchDisplay to end the pause and resume the programme.

* Depending on the serial number (FN)

5.9 Favourites



Simplifies selecting frequently used programmes. You can compile your own favourites. Favourites are easy to start. A maximum of six favourites can be saved.



The appliance door has to be open to define, change or delete a favourite.

Defining favourites

- ▶ Open the appliance door.
- ▶ Press the  button.
 - The adjacent screen appears in the TouchDisplay:
- ▶ Press one of the 6 favourite buttons.
 - The TouchDisplay switches to the adjacent view.

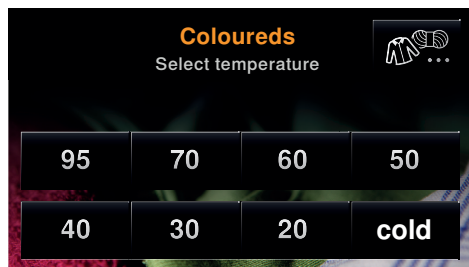
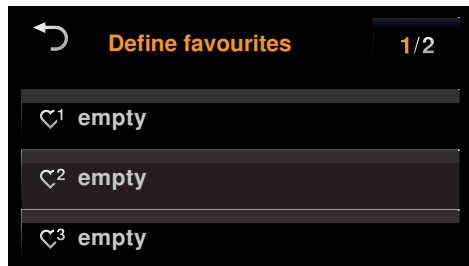



- ▶ Select the desired main programme, additional programmes and additional functions.
- ▶ Then press the  button again.
- ▶ Press the Yes button.
 - The defined favourite is saved.
- ▶ Press the No button.
 - The favourites programme remains empty.

Starting your favourite

- ▶ Close the appliance door.
- ▶ Press the  button.
- ▶ Press the desired favourites programme.
 - The programme starts automatically after about 20 seconds.

Changing your favourite

- ▶ Open the appliance door.
- ▶ Press the  button.
- ▶ Press the desired favourites programme.
- ▶ Press the Change button.
- ▶ Make the desired changes.
- ▶ Press the  button.
- ▶ Press the Yes button.
 - The changes are saved.
- ▶ Press the No button.
 - The changes are discarded.

Deleting a favourite

- ▶ Open the appliance door.
- ▶ Press the  button.
- ▶ Press the desired favourites programme.
- ▶ Press the Clear button.
 - The favourites programme is deleted.

6 User settings

6.1 Adjusting user settings

Providing no programme is running and no error message is displayed, the user settings can be changed. The procedure is generally the same for all settings.

Changing user settings

- ▶ Press the  button.
 - A selection of extra programmes appears in the TouchDisplay.

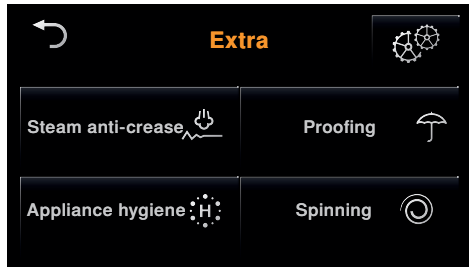

- ▶ Press the  button.
The first of several pages with user settings appears.

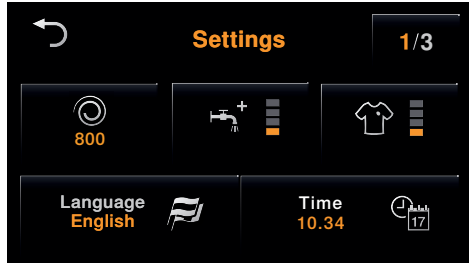

- ▶ Press the desired setting to change it.
 - A selection of possible levels appears.
- ▶ Press the desired level and save with .

To go to the other user setting pages:

- ▶ Press the **1/3** button.
 - The screen changes to the next page.

Exiting user settings

To exit user settings:

Press the  button

6.2 Language

The language in the TouchDisplay can be changed.

6.3 Time

The time must be reset if the appliance has been disconnected from the mains for a longer period of time (about 5 weeks).



To ensure the time is stored, the appliance should not be disconnected from the mains supply for at least 30 minutes after making the settings.

6.4 Spin speed

Each programme and combination of programmes is assigned an optimum spin speed at the factory. This can be adjusted to suit individual needs.

Increasing the spin speed:

To protect delicates, can only be used with suitable programmes (e.g. whites).





Reducing the spin speed:

Can be used with all programmes.

6.5 AquaPlus









There are 5 different settings for rinsing intensity.

-  **«Standard»**
 - Normal water level
-  **«More water»**
 - The water level is increased by around 1–3 cm during the main wash and each rinse cycle.
-  **«+1 rinse»**
 - An extra rinse cycle is added to each programme.
-  **«More water +1 rinse»**
 - An extra rinse cycle is added to each programme and the water level is also increased by around 1–3 cm during the main wash and each rinse cycle.
-  **«Skin protection»**
 - Two extra rinse cycles are added to each programme and the water level is also increased by about 5 cm during each rinse cycle. This function is particularly suitable for people with sensitive skin or with a suspected allergy to washing detergent.



6.6 Degree of soiling



There are three different pre-settings for degree of soiling.

-   **«Soiling light»**
 - Suitable for lightly soiled washing
-   **«Soiling medium»**
 - Wash time extended: 25–80 minutes
-   **«Soiling heavy»**
 - Extended wash time
 - Higher water level during washing
 - Additional rinsing cycle

6.7 Automatic door opener

If the automatic door opener is switched on, the appliance door opens automatically at the end of the programme. Otherwise it remains closed and can be opened by pressing the  or  button.

6.8 Childproof lock



The childproof lock is to prevent children accidentally starting or stopping a programme. When the childproof lock is activated, the appliance can only be operated after first entering a code.

6.9 Hygiene recommendation

It is common nowadays to select programmes with temperatures below 60° C in order to save energy. These achieve perfectly good results with lightly soiled everyday washing. Washing almost exclusively with low temperatures will result in the formation of foul smelling coatings in the appliance. To prevent this, «hygiene info» indicates when it is recommendable to wash with a temperature of at least 60° C or to use the hygiene programme.

6.10 Soft water

The programmes can be adjusted for use with very soft water.

The slightly reduced wash action prevents excessive foaming. Since the detergent does not rinse out as well with soft water, the amount of water used for rinsing is increased slightly and an extra rinse cycle is added.

6.11 Multi-component detergent

If this setting is switched on, after programme selection when the  button is pressed a detergent selection display appears. Depending on the desired detergent, select soap wash (softener and soap detergent), bio wash (alkaline detergent and bleach) or with pre-wash.



6.12 Loosening up the washing

The loosening-up period at the end of the programme can be set to 4 levels:

- 30 seconds*
- 10 minutes
- 30 minutes
- 6 hours

*Factory setting



The washing can be unloaded at any time during the loosening-up phase by pressing the  or  button.

6.13 Brightness



With this function, the readability of the display can be adjusted to the lighting conditions.

1. Dark
2. Medium
3. Bright
4. Very bright

6.14 Button tone

The button tone can be switched on/off.





The button tone for the  button cannot be switched off.

6.15 Background image

The background image of the TouchDisplay can be switched off. In this case, the background is black.

6.16 Silent



The  function can also be assigned to the additional  programme. This lengthens the duration of the programmes slightly, but also makes them quieter because the washing is spun at a lower spin speed.

6.17 Restoring factory settings



The factory settings can be restored.



Any favourites that have been saved will be deleted.

7 Washing

7.1 Preparing the appliance

► Ensure that the foreign body trap **1** is sitting properly.

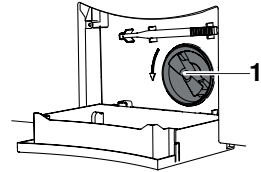

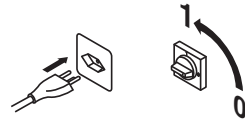

► Plug the appliance in at the mains or turn the wall switch on.
– The appliance switches on.



► Turn on the water tap.



► Press the  or  button to open the appliance door.

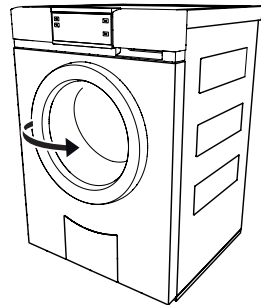

7.2 Loading the appliance

- ▶ Load dry washing (max. 8 kg).
 - If washing normally soiled whites and coloureds, fill the washing drum.
 - If washing heavily soiled whites and coloureds, fill the washing drum max. $\frac{3}{4}$ full.
- If washing easy care cotton fabrics, white and coloured synthetic fabrics as well as mixed fabrics, fill the washing drum max. $\frac{1}{2}$ full.
- If washing delicates, woollens, silks, polyacrylics or net curtains, fill the washing drum max. $\frac{1}{4}$ full.

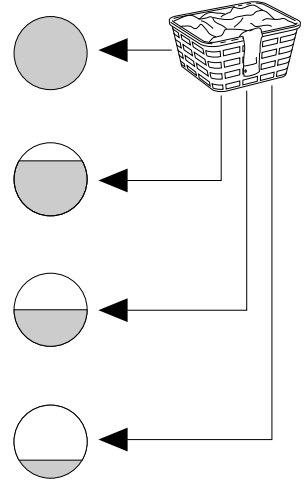

For wet loads, halve these load capacities.

To prevent unbalanced spinning, vibration noise and interrupted spinning action, avoid loading the washing drum with any one single, heavy item.

- ▶ Close the appliance door (pushing firmly to)
 - The start screen appears

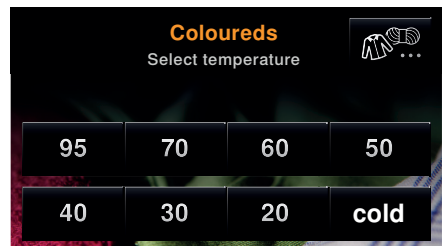

If no programme selection is made within about 20 seconds, all the displays go out. Touch anywhere on the TouchDisplay at any time to display the start screen again.

7.3 Adding washing detergent

- ▶ Pull the detergent dispenser drawer out as far as it will go.

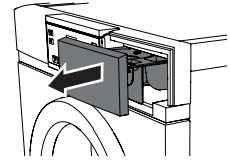

Powder detergent

If using powder detergent, flap **1** in compartment **II** must be removed.

- ▶ Pull flap **1** upwards and out of position **3** and insert in position **2**.

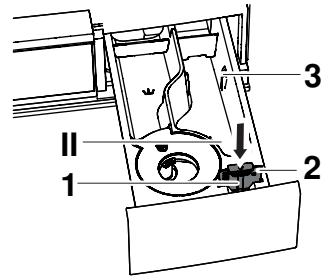

Liquid detergent

If using liquid detergent, flap **1** in compartment **II** must be inserted in position **3**.

- ▶ Pull flap **1** upwards and out of position **2** and insert in position **3**.

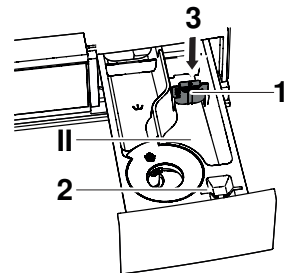

Do not fill with liquid detergent past the upper mark. Liquid detergent can only be used for the main wash with programmes without a pre-wash. They are only suitable for temperatures of up to 60 °C. With 95 °C programmes, liquid detergents are not as effective as they do not contain bleach.



Liquid detergents are best used with very gentle programmes (e.g. «Woollens» and «Hand wash»), low-temperature programmes and programmes with .

Liquid detergent and a delayed start

If a delayed start has been selected, after loading the washing the liquid detergent should be added to a dosing aid (e.g. ball). It is important that the liquid detergent does not spill onto the washing during the delayed start period, otherwise the washing could be damaged through a possible chemical reaction.

Detergent dosage



Adding too much washing detergent can cause excess foaming, giving a poor wash result and, in the worst case, causing damage to the appliance.

The amount of detergent required depends on the degree of soiling as well as the wash load, the hardness of the water and the product being used. Follow the detergent manufacturer's dosing instructions.

The hardness of the water is measured using the French degree of water hardness ($^{\circ}$ fH) and is subdivided into three categories:

- Soft 0 $^{\circ}$ fH to 15 $^{\circ}$ fH
- Medium 15 $^{\circ}$ fH to 25 $^{\circ}$ fH
- Hard over 25 $^{\circ}$ fH

(NB Use water softener to reduce amount of washing detergent required.)

The local water authorities can provide information on the level of water hardness in your area.

Compartment

Pre-wash detergent	Add to compartment I
Main detergent	Add to compartment II
Fabric conditioner (softener)	Add to compartment 

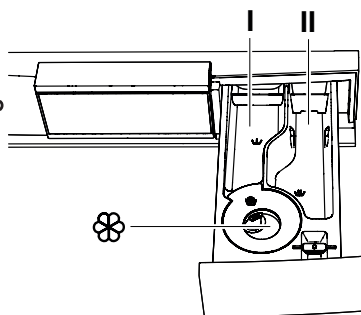

Bio wash

Alkaline detergent	Add to compartment II
Bleach	Add to compartment I
Fabric conditioner (softener)	Add to compartment 

Soap wash

Water softener	Add to compartment I
Soap detergent	Add to compartment II
Fabric conditioner (softener)	Add to compartment 

Fabric conditioner

Do not fill with fabric conditioner past the «MAX» mark.

Do not use fabric conditioner if drying the washing in a tumble dryer. Tumble drying automatically leaves fabrics soft and fluffy.

Soap detergent (softener + soap detergent)

Select the additional «Soap wash» programme to wash with soap detergent. Since soap binds with lime, soap detergent should only be used when the water is soft or moderately hard (up to 25 °fH) and limescale protection is added. Soap scum can otherwise form and build up in the laundry and the appliance. Further, limescale build-up on the tub heating element can result in damage to the appliance.

Dyeing textiles

Textiles can be dyed in the appliance using suitable dyeing agents. Please follow the manufacturer's safety instructions and warnings carefully.



Each wash programme starts with brief draining and for this reason liquid dye components should be added after this.

After adding the wash detergent

- ▶ Push the detergent dispenser drawer back in.
- ▶ Select main programme.

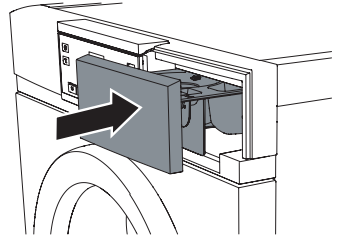

7.4 Selecting a programme

«Press and go»

- After being switched on, the appliance is ready for the user to select a coloureds programme.
- Press one of the temperature buttons displayed to select the coloureds programme with the corresponding temperature.
- All the necessary settings for the programme are assigned automatically.
- The TouchDisplay changes to another view where additional functions can be selected or deselected by pressing the corresponding button.
- If no other button is pressed within the next 20 seconds, the coloureds programme selected starts automatically.

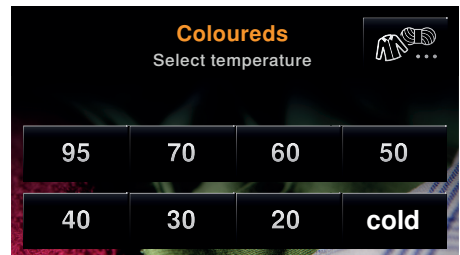

Use the programme overview to determine which programme is the most suitable for your washing.



7.5 Selecting whites and coloureds programmes

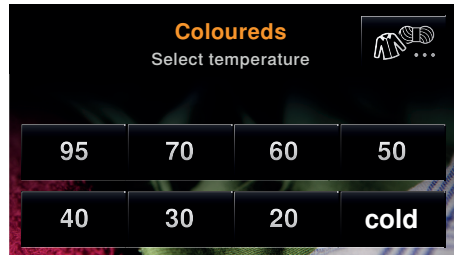

- ▶ Close the appliance door.
 - The following screen appears in the TouchDisplay.

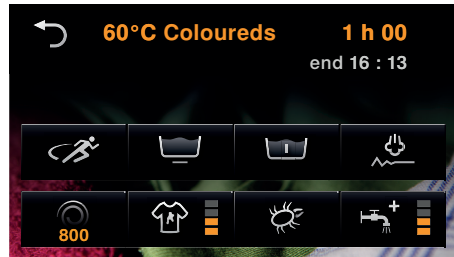

- ▶ Press the desired temperature button, e.g. 60 °C.
 - The TouchDisplay changes to a view where all possible additional functions can be selected or deselected by pressing the corresponding button.





- The programme selected, the likely duration (hours/minutes) and the end time are displayed.
- The indicator lights for the selectable  and  buttons flash.
- If no other button is pressed within the next 20 seconds, the coloureds programme selected starts automatically.

Press the  button at the top left of the TouchDisplay or press the  or  button at any time to cancel the programme selected.

7.6 Selecting another main programme

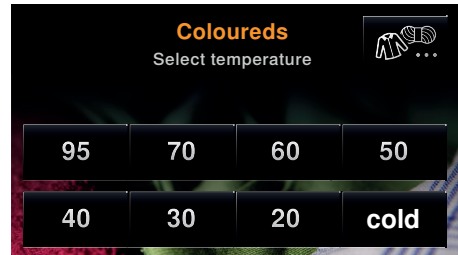
- ▶ Close the appliance door.
 - The following screen appears in the TouchDisplay.



- ▶ Press the  button at the top right of the TouchDisplay.
 - The first of several pages with fabric selection appears.



- ▶ Press the required type of fabric.
 - The TouchDisplay switches back again to the temperature selection page.
 - The selected fabric type is displayed.
 - Only temperatures suitable for the fabric type selected are available for selection.

or:



- ▶ Press the **1/4** button.
 - The screen changes to the next page of fabric selection.

or:

- ▶ Press the  button.
 - The TouchDisplay switches back again to the temperature selection page. The whites/coloureds programme remains selected.

7.7 Selecting programmes for normally soiled cotton load



- ▶ Close the appliance door.
- ▶ Press the flashing  button.
 - The adjacent screen appears in the TouchDisplay:
- ▶ Press the  button to select the programme 40 °C Coloureds normal.

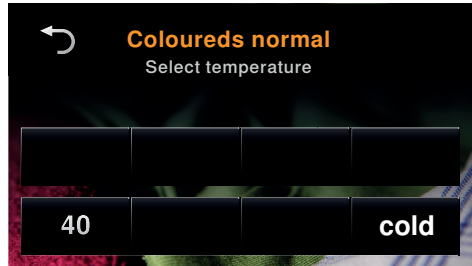

or:

- ▶ Press the  button to select the standard 10 °C Coloureds normal.



With these programmes, it is not possible to change the additional functions. Only delayed start is selectable.





Data of programme 40 °C Coloureds normal

Load capacity	8 kg
Programme duration	3h50
Energy star rating	4.5
Energy consumption	0.69 kWh/cycle
Water star rating	4.5
Water consumption	66 l/cycle
Residual moisture	53 %

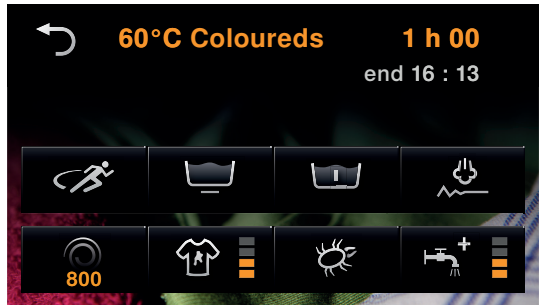

7.8 Selecting additional programmes

After selecting fabric type, e.g. coloureds, and wash temperature, e.g. 60 °C, the display adjacent appears:



-  Sprint
-  Pre-wash
-  Anti-mite
-  Easy care
-  Steam anti-crease

- ▶ Press the desired button in the TouchDisplay.
 - The button changes its colour from dark «selectable» to blue «selected».
 - The new programme duration and programme end time are displayed.

-  AquaPlus
-  Spin speed
-  Degree of soiling

- ▶ Press the desired button, e.g. AquaPlus, in the TouchDisplay.
 - The TouchDisplay switches to the adjacent screen:

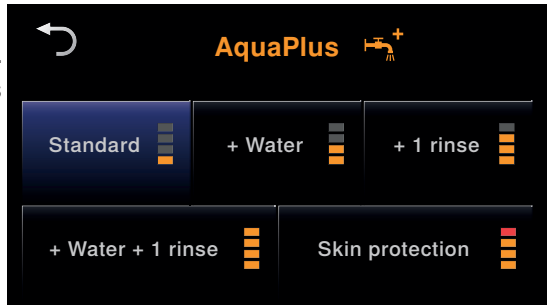

- Alternatives to the corresponding additional function are displayed. The pre-selected state is marked blue.
- ▶ Press the desired setting.
 - The setting is immediately accepted.
 - The TouchDisplay switches back again.

- The additional function that has been changed is shown as «selected» blue and the corresponding setting is displayed.
- The new programme duration and programme end time are displayed.

Selecting Eco

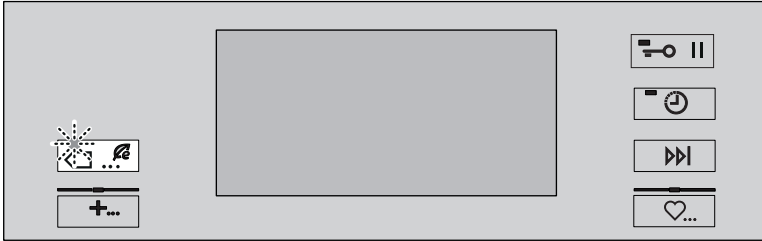

- ▶ Press the  Eco button while the indicator light is flashing.
 - The new programme duration and the programme end time appear in the TouchDisplay.



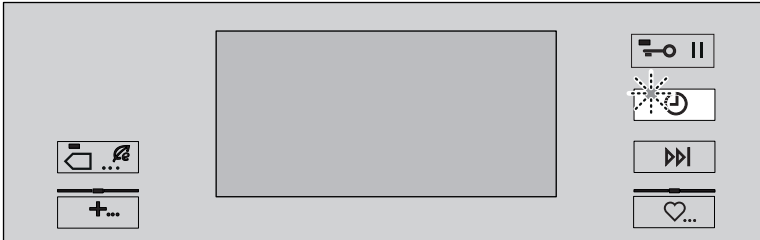

Selecting a delayed start



Delayed start

- ▶ Press the  button while the indicator light is flashing.
 - The TouchDisplay switches to the adjacent screen:





- The digit which can be changed is displayed in orange.
 - After a digit has been entered, the orange marking switches automatically to the next digit.
 - ▶ Enter the desired programme end time.
 - ▶ Confirm with  (or with  back to additional function selection without delayed start).
 - The TouchDisplay switches back again to additional function selection and goes dark.
 - The programmed end time and the calculated start time of the programme is displayed.
 - The programme starts automatically when the start time set is reached.
-  Washing can be added at any time. The desired end time can be changed at any time by pressing the  button and entering another programme end time.



Selecting separate rinsing / separate spinning

- ▶ Select programme.
- ▶ Press the  button 1×.
 - The programme starts from rinse.
- ▶ Press the  button 2×.
 - The programme starts from last rinse.
- ▶ Press the  button 3×.
 - The programme starts from final spin.

7.9 Opening the appliance door during operation

The appliance door can only be opened if the water level and temperature are still low and there is no spinning in progress. As long as the indicator light for the  or  button is illuminated, the appliance door can be opened.

For appliances with the button

- ▶ Press the  button 1×.
 - The appliance changes over to the «Pause» mode.
- ▶ Press the  button again.
 - The appliance door opens.
- ▶ Add or unload wash items.
- ▶ Close the appliance door.
 - The programme is resumed.

For appliances with the button

- ▶ Press the  button.
 - The appliance door opens.
- ▶ Add or unload wash items.
- ▶ Close the appliance door.
 - The programme is resumed.





In the event of a power failure, the appliance door can only be opened using the emergency door release.

The programme memory ensures that the programme sequence is resumed after a power failure.

7.10 Changing selection

During programme selection

- ▶ Press the  or  button.
 - All settings are cleared.
- ▶ Press the  button.
 - The changes at the active level are not accepted.
 - The TouchDisplay switches back to the previous screen.

After a programme has started

The spin speed and temperature can still be changed. To change any other settings, the programme must be aborted.

Aborting a programme

- ▶ Press the  button repeatedly until the «Draining» part of the programme appears in the TouchDisplay.
 - This part of the programme cannot be skipped and will be carried out in full.

7.11 Programme selection with childproof lock activated

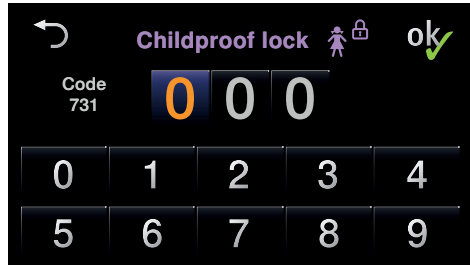

How to switch the childproof lock on/off is described in 'User settings'.

- ▶ Close the appliance door
 - The following display appears:



- ▶ One after the other, press the digits 7, 3, 1. Confirm with **ok**.
 - A programme can now be selected.
 - If no programme selection is made within 30 seconds, the childproof lock is activated again.

Aborting a programme



- ▶ Press the  button
 - The above display appears again.
 - Enter the code to override the childproof lock.
- ▶ Press the  button again until the «Draining» part of the programme appears in the TouchDisplay.

7.12 End of programme

Loosening up the washing



Shortly before the end of the programme, the washing is loosened up. If steam anti-crease has been selected, the loosening-up period is extended to about 60 minutes to prevent further creasing.



Press the  or  button to unload the washing at any time during the loosening-up phase.

With «Automatic door opener OFF»

When the programme has finished, the following appears in the TouchDisplay for about 20 minutes: **End of programme**

- ▶ Press the  or  button.
 - The appliance door opens and the washing can be unloaded.





In the event of a power failure, the appliance door can only be opened using the emergency door release.

With «Automatic door opener ON»

- The appliance door opens automatically at the end of the programme. The washing can be unloaded.

With «Stop after rinsing»

The washing remains lying in the water after the final rinse. The water must be drained off before the washing can be unloaded.

- ▶ Press the  button 1x.
 - The washing is spun at the spin speed set for the programme selected.
- ▶ Press the  button 2x.
 - Draining without spinning.

With the hygiene recommendation display

- ▶ One of the next times you wash, run a minimum 60 °C wash programme or the appliance hygiene programme.

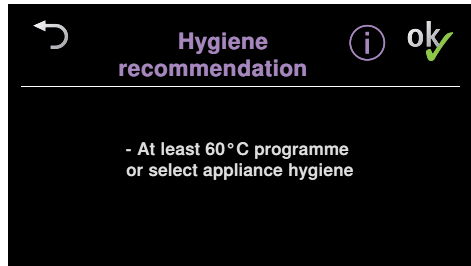

7.13 At the end of the wash day

- ▶ Clean the detergent dispenser drawer if necessary.
- ▶ After finishing washing for the day, remove any deposits or foreign bodies from out of the door seal
- ▶ Push the appliance door to, but do not close.
 - This allows the washing drum and the door seal to dry.

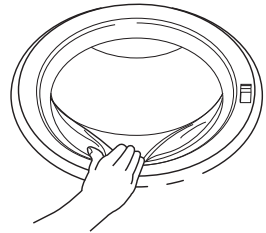

8 Care and maintenance

Using the correct dosage of detergent will automatically clean the inside of the appliance. Immediately wipe away all traces of detergent with a soft cloth to avoid staining.

8.1 Cleaning the detergent dispenser drawer

If the correct dosage of detergent is used, the compartments in the detergent dispenser drawer are cleaned by the water flowing in. Wash out the detergent compartments if particularly soiled.

Cleaning the detergent compartments

- ▶ Pull the detergent dispenser drawer **1** out as far as it will go, push the release lever **4** to the left and then remove the drawer completely.
- ▶ Wash out the detergent compartments.
- ▶ Clean the duct under the pre-wash detergent compartment **1**.

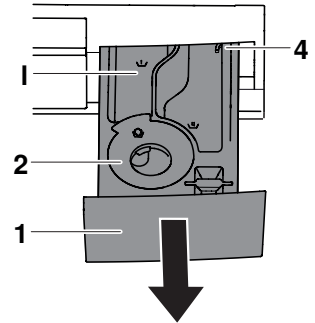

Cleaning the siphon and suction tube

- ▶ Pull the siphon **2** in the fabric conditioner compartment  up in the direction of the arrow.
- ▶ Clean the siphon **2** and suction tube **3**.
- ▶ Replace the siphon correctly.

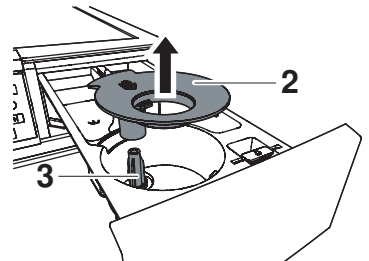

8.2 Cleaning the water inlet filter

To avoid blockages, the filter **1** in the water inlet must be periodically checked and, if necessary, cleaned.

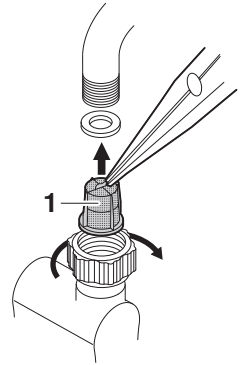

The water inlet should be tested for leaks following maintenance work.

8.3 Emergency draining



The water in the appliance may be hot. Scalding hazard! Allow to cool before emergency draining.

In the event of a blocked water outlet or drain pump, a malfunction or a power failure, if there is water still in the appliance it must be drained off as follows:

- ▶ Open the drain tray **1** by pressing it at the bottom.

or:

Open the drain tray **1** with the liquid detergent flap.

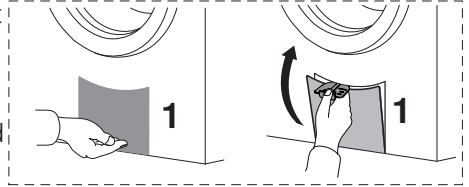

- ▶ Fold the drain tray **1** right down.
 - The drain tray also functions as a receptacle for collecting the water being drained off.

- ▶ Release the foreign body trap **2** slightly by slowly turning it anti-clockwise. Steadily drain off the water.

From time to time the drain tray may have to be emptied.

- ▶ Close the foreign body trap by turning it clockwise and remove the drain tray **1** from the front.

- ▶ Empty the drain tray and then put it back in position (push it straight in until it clicks into position).

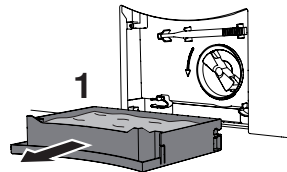
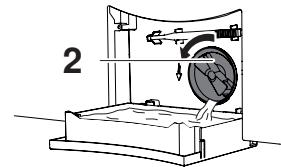
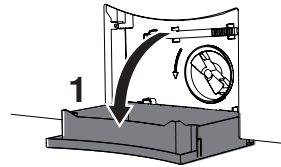

When draining off the water, the drain tray can be removed and a larger receptacle used in its place. The appliance can hold up to 30 litres of water.

8.4 Cleaning the foreign body trap

The foreign body trap **1** must be periodically cleaned of any deposits.



The foreign body trap should also be cleaned after washing e.g. pet blankets or other wash items that cause a thick build-up of fluff.

- ▶ Drain off any residual water, see section on «Emergency draining».
- ▶ Then turn the foreign body trap **1** anti-clockwise and remove. Clean thoroughly.
- ▶ Remove any foreign objects (buttons, coins, etc.).
- ▶ Check that the drain pump impeller **2** can turn. Use the emergency door release tool **3** for this.
- ▶ If the impeller **2** does not turn, please contact Customer Services.

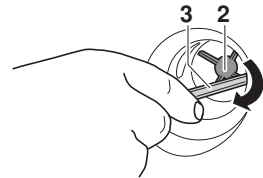
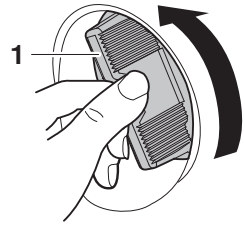

The impeller **2** may turn stiffly. This is construction related and does not indicate the presence of any foreign object or defect.

- ▶ Insert the foreign body trap **1** – with the arrow-shaped positioning lug **4** facing upwards – as far as it will go.
- ▶ Then turn the whole thing clockwise as far as it will go.

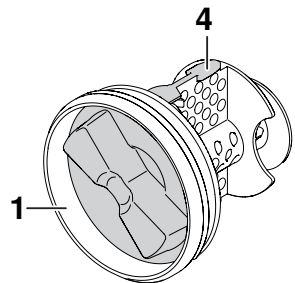

- ▶ Replace the drain tray and close it to.

9 Troubleshooting

9.1 What to do if ...

This section lists faults that can be solved simply by following the instructions given. If another fault is displayed or the fault cannot be remedied, please call Customer Services.



Before calling Customer Services, please note down the error message in full.

FXX/EXXX FNXXXXX XXXXXX see instructions

... in the display appears

A2 Check water outlet

Possible cause	Solution
<ul style="list-style-type: none">• The foreign body trap or drain pump is blocked.• The drain hose is bent or kinked.• The outlet or drain trap is clogged.	<ul style="list-style-type: none">▶ Resolve the cause of the problem.▶ Cancel the error message by pressing the  button.▶ Restart the programme.

... in the display appears

A3 Clean foreign body trap

Possible cause	Solution
<ul style="list-style-type: none">• The foreign body trap is clogged.• The circulation nozzle is clogged.	<ul style="list-style-type: none">▶ Remove the cause of the problem.▶ Cancel the error message by pressing the  button.▶ Restart the programme.

... in the display appears

A5 Spin stop: Unbalanced load

Possible cause	Solution
<ul style="list-style-type: none"> • Large items are unevenly distributed in the washing drum. 	<ul style="list-style-type: none"> ▶ Wash large and small items together to reduce the possibility of unbalanced loads forming.
<ul style="list-style-type: none"> • Pillows or similar items in the wash. 	<ul style="list-style-type: none"> ▶ Remove the pillows. ▶ Spin the washing again. ▶ Spin the pillows separately.
<ul style="list-style-type: none"> • Wash items are tangled. 	<ul style="list-style-type: none"> ▶ Separate the wash items. ▶ Fasten duvet covers and pillow cases. ▶ Spin the washing again.

... in the display appears

A6 Check foreign body trap

Possible cause	Solution
<ul style="list-style-type: none"> • The foreign body trap is missing or is not sitting correctly. 	<ul style="list-style-type: none"> ▶ Ensure the foreign body trap is sitting correctly. ▶ Cancel the error message by pressing the  button. ▶ Restart the programme.

... in the display appears

A9 Check water inlet

Possible cause	Solution
<ul style="list-style-type: none"> • The water tap is turned off. • The mesh filter in the water connection is clogged. • Interruption in water supply. • The water pressure is too low. 	<ul style="list-style-type: none"> ▶ Remove the cause of the problem or wait until the water supply is restored. ▶ Cancel the error message by pressing the  button. ▶ Restart the programme.

... in the display appears

F6/E77 FNXXXXX XXXXXX see instructions

Possible cause	Solution
<ul style="list-style-type: none"> • Related to anti-leak protection. 	<ul style="list-style-type: none"> ▶ Turn off the water tap. ▶ Note down the error message in full (message, F and E number). ▶ Cancel the error message by pressing the  button. ▶ Call Customer Services.

... in the display appears

Possible cause	Solution
<ul style="list-style-type: none"> • Various situations can lead to an «F» message. 	<ul style="list-style-type: none"> ▶ Cancel the error message by pressing the  button. ▶ Switch off the power supply for about 1 minute. ▶ Switch the power supply back on again and select a new programme. ▶ If the error appears again, note down the error message in full (message, F and E number) ▶ Turn off the water supply and switch off the power supply. ▶ Call Customer Services. <p>If there is still some washing in the appliance:</p> <ul style="list-style-type: none"> ▶ Carry out emergency draining. ▶ Use emergency door release. ▶ Unload the washing. ▶ Call Customer Services.

... in the display appears

U1/E27 FNXXXXXX XXXXXX see instructions

Possible cause	Solution
<ul style="list-style-type: none"> • Faulty electrical connection. • Overvoltage 	<ul style="list-style-type: none"> ▶ Cancel the error message by pressing the  button. ▶ Switch off the power supply for about 1 minute. ▶ Switch the power supply back on again and select a new programme. <p>If the error appears again:</p> <ul style="list-style-type: none"> ▶ Switch the power supply off. ▶ Have an electrician check the house installation. <p>If the error appears again:</p> <ul style="list-style-type: none"> ▶ note down the error message in full and the serial number (FN) and then disconnect the power supply. ▶ Call Customer Services.

... in the display appears

Foam in main wash, rinsing extended

Possible cause	Solution
<ul style="list-style-type: none"> • If there is very heavy foaming during the wash cycle, the programme is automatically extended by an additional rinsing cycle. This improves the wash results, but also increases the duration of the programme. 	<ul style="list-style-type: none"> ▶ Reduce the amount of washing detergent used next time. ▶ Adjust the amount of washing detergent used to the water hardness.

... in the display appears

Hygiene recommendation: Select at least a 60 °C programme or appliance hygiene

Possible cause	Solution
<ul style="list-style-type: none"> No wash cycle has been carried out at a temperature of at least 60 °C for a longer period of time. 	<ul style="list-style-type: none"> ▶ With one of the next wash cycles carry out a wash with at least 60° C. <p>or:</p> <ul style="list-style-type: none"> ▶ Run the «Appliance hygiene» programme without any washing.

... the programme takes significantly longer than indicated

Possible cause	Solution
<ul style="list-style-type: none"> Using too much washing detergent. Lengthening the rinsing time. 	<ul style="list-style-type: none"> ▶ Reduce the amount of washing detergent used next time.
<ul style="list-style-type: none"> Large unbalanced load in the washing drum. 	<ul style="list-style-type: none"> ▶ Wash large and small items together to reduce the possibility of unbalanced loads forming.
<ul style="list-style-type: none"> Inlet water very cold. Heating is extended. 	

... in the display appears

Inlet water very cold, heating extended

Possible cause	Solution
<ul style="list-style-type: none"> Inlet water very cold. Heating is extended. 	

... in the display appears

Too many articles, heating extended

Possible cause	Solution
<ul style="list-style-type: none">Selected programme is intended for a reduced washing load. If there are too many articles, heating and possibly also the rinsing will be extended.	With the next wash cycle adjust the amount of articles to the max. washing load (see 'Programme overview').

... the washing is not spinning or is not being spun properly

Possible cause	Solution
<ul style="list-style-type: none">The spin speed set is too low.	▶ Increase the spin speed for the next wash cycle.
<ul style="list-style-type: none">Too unbalanced a load in the washing drum. The wash items cannot be more evenly distributed.	▶ Wash large and small items together to reduce the possibility of unbalanced loads forming.
<ul style="list-style-type: none">Steam anti-crease was selected and the appliance was not standing level.	▶ Optimize the appliance set-up according to the installation instructions.

... in the display appears



Large unbalanced load, spin extended

Possible cause	Solution
<ul style="list-style-type: none">Large unbalance in the washing drum. The appliance tries to improve the distribution of the wash load. The final spin is extended.	▶ Wash large and small items together to reduce the possibility of unbalanced loads forming.

... vibrating heavily when spinning

Possible cause	Solution
<ul style="list-style-type: none"> The transportation lock has not been removed. 	<ul style="list-style-type: none"> ▶ Remove transportation lock.
<ul style="list-style-type: none"> The feet of the appliance are not properly adjusted. 	<ul style="list-style-type: none"> ▶ Optimize the appliance set-up according to the installation instructions.
<ul style="list-style-type: none"> The load could not be optimally balanced in the washing drum. This is not a malfunction. 	<ul style="list-style-type: none"> ▶ Wash large and small items together to reduce the possibility of unbalanced loads forming.

... at the end of the programme, the appliance door cannot be opened by pressing the door opener button

Possible cause	Solution
<ul style="list-style-type: none"> The appliance door is stuck. 	<ul style="list-style-type: none"> ▶ Press hard against the lock side of the appliance door (i.e. front edge of appliance door). ▶ Some text appears in the plain text display. ▶ Press the  or  button.
<ul style="list-style-type: none"> An interruption in the power supply. 	<ul style="list-style-type: none"> ▶ Use emergency door release.

... at the end of the programme water sounds can be heard when the washing drum is turned by hand

Possible cause	Solution
<ul style="list-style-type: none"> The water that the vanes were filled with to compensate the unbalanced load could not be completely drained before the end of the programme. 	<p>No action is necessary. The expelled water is automatically pumped off and there are no negative consequences.</p>





... traces of washing detergent left behind in the washing detergent compartment

Possible cause	Solution
<ul style="list-style-type: none"> • Damp or lumpy washing detergent. 	<ul style="list-style-type: none"> ▶ Store washing detergent in a dry place.
<ul style="list-style-type: none"> • The washing detergent compartment was damp and a delayed start was selected. 	<ul style="list-style-type: none"> ▶ Wipe the washing detergent compartment dry before adding the detergent.
<ul style="list-style-type: none"> • The water flow pressure is too low. 	<ul style="list-style-type: none"> ▶ Open water tap fully.
<ul style="list-style-type: none"> • The water inlet is scaled up. 	<ul style="list-style-type: none"> ▶ Check the water supply and, if necessary, clean the filter. ▶ Clean nozzles above detergent dispenser drawer.
<ul style="list-style-type: none"> • The liquid detergent flap was inserted. 	<ul style="list-style-type: none"> ▶ Remove the flap and stow away.

... traces of fabric conditioner or water left behind in the fabric conditioner compartment

Possible cause	Solution
<ul style="list-style-type: none"> • The siphon in the fabric conditioner compartment is missing or is not in place correctly. 	<ul style="list-style-type: none"> ▶ Ensure the siphon is in place correctly.
<ul style="list-style-type: none"> • The siphon or suction tube is clogged. 	<ul style="list-style-type: none"> ▶ Clean the siphon and suction tube.

... the washing load is still dry at the end of the programme and no error message is displayed

Possible cause	Solution
<ul style="list-style-type: none"> «Demo mode» is switched on. 	<ul style="list-style-type: none"> ▶ Open the appliance door. ▶ Hold the  and /  buttons depressed. ▶ Simultaneously press the  button. <p>In the TouchDisplay appears: Status of demo mode: ON</p> <p>Turn the demo mode off by pressing the relevant button in the TouchDisplay and save with ok.</p>

9.2 Opening the appliance door in the event of a power failure



Ensure that the washing drum is stationary. Do not touch the drum while it is still in motion – risk of serious injury.



If the emergency door release tool **2** is missing, a screw driver can be used instead.

- ▶ Turn off the water tap.
- ▶ Disconnect the appliance from the electricity supply.
- ▶ Open the drain tray **1** by pressing it at the bottom.

or:

- ▶ Open the drain tray **1** with the liquid detergent flap.
- ▶ Fold the drain tray right down.
- ▶ If necessary, carry out emergency draining.
- ▶ Remove the drain tray **1**.
- ▶ Remove the emergency door release tool **2** from its fastening.
- ▶ Insert the emergency door release tool into the blue opening cap **3** and turn in the direction of the arrow.

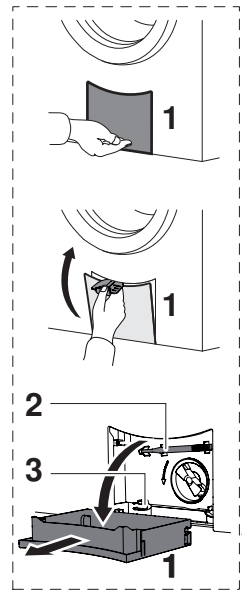

- The appliance door springs open.

Door hinged left

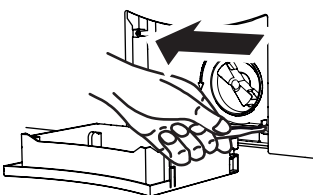

Door hinged right

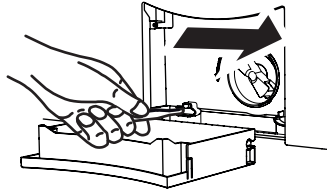

10 Washing tips



10.1 Fabric care symbols

To wash items correctly, please follow the fabric care symbols on the labels of the wash items.

10.2 Washing detergent

The wash temperature selected should agree with the recommended temperature range of the washing detergent to ensure the washing detergent is at its most effective.

10.3 General tips

- Wash white and coloured textiles separately.
- Empty pockets and turn inside out. Remove any foreign objects (coins, nails, paper clips, etc.).
- Empty and brush out pockets of work overalls worn in the metal industry (metal shavings can damage the washing and cause rust stains).
- Fasten duvet covers and pillow cases; close zips and hook and eye fasteners; fasten cloth belts and apron ties.
- Wash smaller items (e.g. nylon tights, belts) and items with zips and hooks in a washing net or cushion cover.
- Remove stains before washing using a suitable stain remover.
- Pre-treat heavily soiled areas (collars, cuffs, etc.) with soap, special detergent or paste.
- For medium or heavily soiled washing, select the additional  pre-wash programme or select a heavier degree of soiling.
- Wash woollens and other textiles with the  fabric care label using the main  hand wash programme only. Use detergent suitable for woollens and delicates.
- Textiles, such as dog or horse blankets, that are covered in animal hair should be brushed out before washing

10.4 Net curtains

If washing curtains made from mixed or man-made fibres:

- Ask the retailer whether the curtains are machine washable and, if so, at what water temperature.
- Fill the washing drum only a quarter full.
- Tie up metal rollers and plastic sliders using an open weave fabric.
- Use a mild detergent (use sparingly due to foaming).
- With older, faded curtains, the material is weaker and may be easily damaged if machine washed.

10.5 Saving energy and water

- Use the maximum wash load capacity of the particular programme.
- Select «Pre-wash» or «Soaking» only for washing that is heavily soiled or stained.
- For lightly soiled washing without staining select the main 20 programme or the additional «Sprint» function.
- Select the additional Eco function if programme duration plays no role.

Spin speed

How much energy is consumed by subsequent tumble drying depends on the spin speed set. The higher the spin speed set, the lower the level of residual moisture in the washing at the end of the programme.

rpm	Residual moisture in cotton fabrics in %
1600	~44
1400	~47
1200	~52
1000	~60
800	~70
600	~90
400	~110

Automatic door opener

Use the appliance with the automatic door opener turned on. In this way, when the appliance door opens the appliance immediately enters the lowest possible stand-by power consumption state.

10.6 Unsatisfactory wash results

White residue on washing

Possible cause	Solution
<ul style="list-style-type: none">• Despite thorough rinsing, badly soluble compounds (zeolites) in the detergent can be left on the washing.	<ul style="list-style-type: none">▶ Shake out or brush the wash items.▶ Wash the items again with just a little washing detergent.▶ Use a liquid detergent that does not contain zeolites.▶ Select the additional «Black garments» programme.

Grey residue on washing

Possible cause	Solution
<ul style="list-style-type: none">• Grease and dirt particles have not been removed from fabric effectively.• Residue from detergent, limescale and dirt.	<ul style="list-style-type: none">▶ Use more detergent next time.▶ Use heavy-duty washing detergent.▶ Adjust amount of detergent to water hardness and degree of soiling of washing.
<ul style="list-style-type: none">• Overloaded washing drum.	<ul style="list-style-type: none">▶ Put less laundry into the washing drum.

Washing feels hard to the touch

Possible cause	Solution
<ul style="list-style-type: none">• Poor rinse effect from «very soft» water (below 15 °fH).	<ul style="list-style-type: none">▶ Select the «Soft water» user setting.

Unsatisfactory wash result using detergent for coloureds

Possible cause	Solution
<ul style="list-style-type: none"> Exceptionally heavily soiled washing. 	<ul style="list-style-type: none"> ▶ Select stronger wash programme, e.g. degree of soiling «heavy».
<ul style="list-style-type: none"> Washing detergent used does not contain bleach. Fruit, coffee and tea stains cannot be removed. 	<ul style="list-style-type: none"> ▶ Use washing detergent containing bleach.

Unsatisfactory wash result using liquid detergent

Possible cause	Solution
<ul style="list-style-type: none"> Liquid detergent used does not contain bleach. Fruit, coffee and tea stains cannot be removed. 	<ul style="list-style-type: none"> ▶ Use washing detergent containing bleach.

Soap deposits on washing

Possible cause	Solution
<ul style="list-style-type: none"> Water too hard. 	<ul style="list-style-type: none"> ▶ Only use soap detergent if the water hardness does not exceed 25 °fH.

Colour run

Possible cause	Solution
<ul style="list-style-type: none"> Non-fast colours in the wash. 	<ul style="list-style-type: none"> ▶ Wash white and coloured textiles separately. ▶ Follow the fabric care instructions on the items of washing.
<ul style="list-style-type: none"> Objects in the wash whose colour has run. 	<ul style="list-style-type: none"> ▶ Empty garment pockets.

Unsatisfactory rinsing performance

Possible cause	Solution
<ul style="list-style-type: none"> • Too much washing detergent. 	<ul style="list-style-type: none"> ▶ Adjust washing detergent dosage to water hardness and degree of soiling.
<ul style="list-style-type: none"> • Very «soft» water (below 15 °fH). 	<ul style="list-style-type: none"> ▶ Set to the soft water setting (see 'User settings').

Fabric stains

Possible cause	Solution
<ul style="list-style-type: none"> • Rust stains. • Chemical effect. 	<ul style="list-style-type: none"> ▶ Brush out work overall pockets. ▶ Residues from hair care products, cosmetics and plants can react with the suds to cause a chemical reaction that can result in staining. ▶ Wash items with metal parts separately.

Holes, rips or tears

Possible cause	Solution
<ul style="list-style-type: none"> • Washing items with zips or hooks (e.g. bras) open. 	<ul style="list-style-type: none"> ▶ Fasten zip fasteners and hooks before washing. ▶ Wash delicates in a laundry bag or pillow case. ▶ Turn garment pockets inside out.
<ul style="list-style-type: none"> • Chemical effect of washing detergent. • Fabric quality, wear and tear, weathering of fibres. 	<ul style="list-style-type: none"> ▶ Do not put washing detergent directly on to fabrics.
<ul style="list-style-type: none"> • Washing drum damaged by foreign objects (e.g. nails, paper clips, bra hooks). 	<ul style="list-style-type: none"> ▶ Inspect the washing drum for foreign objects and for damage. ▶ Remove foreign objects. ▶ Call Customer Services if the washing drum is damaged.

Fabric wear

Possible cause	Solution
• Washing drum over-loaded.	▶ Put less laundry into the washing drum.
• Friction between fabrics during washing.	▶ Select the additional  «Easy care» programme.
• Pilling.	▶ Turn items inside out before washing.

11 Spare parts

Please give product family and exact designation when ordering parts.

Drain hose 1.5 m / 4.0 m

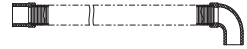

Emergency door release tool



Foreign body trap

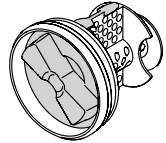

Drain tray

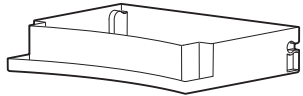

Siphon



Detergent dispenser drawer

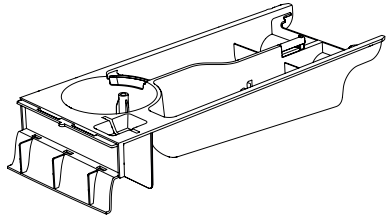

Liquid detergent flap

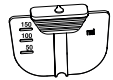

12 Technical data

12.1 Dimensions

Height:	85 cm
Width:	59.5 cm
Depth:	60 cm
Empty weight:	71 kg
Dry load capacity:	8 kg

12.2 Plumbing in

Connection to water supply:	Cold water G $\frac{3}{4}$ "
Permitted pressure of water supply:	0.1–0.6 MPa (1–6 bar)
Max. pumping height of drain pump:	1.2 m

12.3 Electrical connection

- See identification plate 1

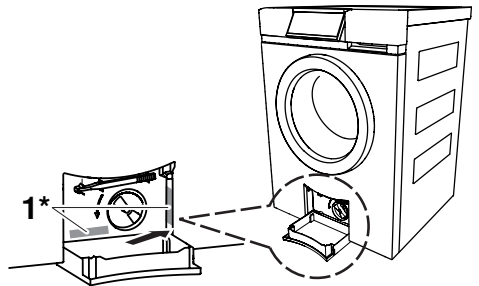

* Depending on the serial number (FN)

12.4 Spin speed

400, 600, 800, 1000, 1200, 1400, 1600 rpm

12.5 Consumption data

The consumption data and programme durations given serve only as a guide. They refer to the maximum load capacity and can vary with, for instance, towelling material, a very cold water feed, the degree of soiling selected or a smaller wash load. The time remaining and the programme end time shown are adjusted during the programme sequence accordingly.

Whites and coloureds programmes, soiling light

Programme	Load kg	Spin speed ¹ rpm	Duration ² hrs./mins.		Water Litre	Energy kWh
Whites 95 °C	1–8	1200	1h38	2h15	75	2.2
Coloureds 70 °C	1–8	1200	1h30	2h00	65	1.6
Coloureds 60 °C	1–8	1200	1h15	1h32	65	1.3
Coloureds 40 °C	1–8	1200	1h05	1h14	70	0.8
Coloureds 30 °C	1–8	1200	1h02	1h05	70	0.5
Coloureds 20 °C	1–8	1200	0h59	1h00	70	0.3
Coloureds cold	1–8	1200	0h58	0h58	70	0.2



¹ Factory setting

² The longer programme duration is valid for 230 V~ 50 Hz, 10 A mains connection.

Fabric types

Programme	Load kg	Spin speed ¹ rpm	Duration ² hrs./ mins.	Water Litre	Energy kWh
Shirts 40 °C	Max. 7 shirts/ blouses	1000	1h23	33	0.4
Woollens 30 °C	1–1.5 kg	800	0h48	52	0.3
Hand wash 20 °C	1–2 kg	600	0h45	58	0.2
Down filling 40 °C	1 item, max. 2 kg	800	1h25	40	0.5
Outdoor garments 40 °C	max. 3 kg	1000	1h05	40	0.4
Silks 30 °C	max. 1.5 kg	400	0h48	52	0.3
Underwear 30 °C	max. 3 kg	800	1h05	40	0.3
Baby garments 60 °C	max. 5 kg	1200	1h50	120	1.6
Denim 40 °C	max. 4 kg	1200	1h16	55	0.5
WetClean 20 °C	max. 1.5 kg	400	0h55	60	0.2
Net curtains 30 °C	max. 2 kg	Stop after rinsing	1h00	45	0.4
Black garments 40 °C	max. 4 kg	1200	1h20	85	0.5
Black hand wash 20 °C	max. 1.5 kg	600	0h58	68	0.2



Extra programmes

Programme	Load kg	Spin speed ¹ rpm	Duration hrs./mins.	Water litres	Energy kWh
Steam anti-crease	1–1.5	None 	0h23	1	0.1
Proofing 20 °C	1–3	800	0h28	12	0.1
Appliance hygiene	0	None 	0h30	9	0.7



12.6 Note for testing institutes

Set to the test according to AS/NZS 2040.2:2005

Programme 40 °C Coloureds normal

- ▶ Press the  button.
- ▶ Press the  button in the TouchDisplay.
 - The programme 40 °C Coloureds normal is selected.

Programme 10 °C Coloureds normal

- ▶ Press the  button.
- ▶ Press the  button in the TouchDisplay.
 - The programme 10 °C Coloureds normal is selected.

12.7 VAS Vibration Absorbing System

As the washing drum starts to spin, if the control unit detects that the load is out of balance it will interrupt the spinning action once or more. In this case, the appliance tries to improve the distribution of the wash load in the washing drum.

When spinning, at all spin speeds the load is, where necessary, actively balanced in the washing drum, whereby the hollow vanes are filled with the necessary quantity of water. This ensures optimal care and draining of the washing.

12.8 Water and energy economy

During the first few minutes of a programme running, sensors automatically determine the type and the size of the load being washed.

Water levels are then optimally adjusted to the wash load so that only the strict amount of water needed is used.

12.9 Automatic energy-saving stand-by

The appliance is equipped with automatic energy-saving stand-by to avoid consuming energy unnecessarily.

All displays go out within minutes of a programme finishing. Energy consumption is reduced to an absolute minimum. The safety functions, however, remain activated.

Power consumption in accordance with AS/NZS 2040.2:2005

- In «OFF mode»: 0 watts
- In «Left-on mode»: 0 watts

13 Index

A

- Aborting a programme
 - Aborting 51
 - After a programme has started 51
 - During programme selection.. 51
- Additional functions18, 29
 - Delayed start 18
 - Door opener18
 - Economy programme 18
 - End of programme 18
 - Fast forward 18
 - Pause 18
- Additional programmes 25
 - Selecting 47
- Allergies27, 34
- Anti-mite26, 47
- Appliance
 - Construction 16
 - Description 15
 - Preparing 38
- Appliance door 16
 - Checking the door seal 54
 - Door does not open 65
 - Opening during operation 50
 - Opening in the event of a power failure 68
- Appliance hygiene 21
- AquaPlus 27, 34, 47
- Automatic door opener ... 35, 53, 71
- Automatic water and energy economy 81

B

- Background image37
- Before using for the first time 10
- Bio wash27
- Brightness 36
- Button state 18

C

- Care55
- Caution: Burns hazard! 11
- Caution: Risk of injury!11
- Changing user settings32
- Childproof lock35
- Cleaning
 - Detergent dispenser drawer ... 55
 - Foreign body trap 58
 - Siphon 55
 - Water inlet filter56
- Colour run 73
- Coloureds programme
 - Selecting 44
- Correct use 10

D

Damage to fabrics	74
Degree of soiling	26, 34
Delayed start	29, 41
Selecting	49
Deposits on washing	73
Detergent dispenser drawer ..	16, 76
Cleaning	55
Traces	66
Detergent dosage	41
Dimensions	77
Disconnection	13
Display	17
A messages	59, 60
F messages	61
Display elements	17
Disposal	13
Door opener	
Automatic	53
Door seal	
Checking	54
Drain hose	76
Drain tray	16, 76
Dyeing	43

E

Easy care	25, 47
Eco	25
Selecting	48
Electrical connection	77
Faulty	62
Emergency door release	16
Emergency door release tool ...	16,
68,	76
Emergency draining	57
End of the wash day	54
Extra programmes	17, 80
Appliance hygiene	17
Proofing	17
Spinning	17
Steam anti-crease	17

F

Fabric care symbols	69
Fabric conditioner	16, 42
Conditioning	28
Traces	66
Fabric stains	74
Fabric wear	75
Factory settings	37
Fast forward	29
Favourites	17, 30
Foam in main wash	62
Foreign body trap	16, 58, 76
Checking	60
Cleaning	58, 59

G

General note	71
Grey residue on washing	72

-
- H**
- How to avoid damaging the appliance12
 - Hygiene recommendation35, 63
- I**
- Identification plate 16
 - Inlet water very cold 63
- L**
- Language33
 - Large unbalanced load64
 - Liquid detergent 40
 - Liquid detergent flap 16, 76
 - Load capacity 15
 - Loosening up the washing36, 53
- M**
- Main programme
 - Selecting another 45
 - Main wash detergent 16
 - Main wash programmes 19
 - Maintenance 55
 - Model no.2
 - Multi-component detergent 36
- N**
- Net curtains 70
 - Note on use 10
- O**
- Opening the appliance door during operation
 - Opening 50
 - Pause50
 - Operating elements 17
 - Overvoltage 62
- P**
- Packaging 13
 - Pause
 - Continuing the programme 29
 - Door opener29
 - Programme pause 29
 - Plumbing77
 - Powder detergent 40
 - Power failure68
 - Pre-wash25, 47
 - Pre-wash detergent 16
 - Product family2
 - Programme
 - 10°C Coloureds normal 80
 - 40°C Coloureds normal 80
 - End29, 53
 - Taking too long 63
 - Proofing 21
- Q**
- Quick instructions 88
- R**
- Repair service 87
 - Rinsing performance
 - Unsatisfactory 74

S

Safety	13
Safety precautions	
Before using for first time	10
General	7
Saving	
Energy	71
Water	71
Selecting programmes for normally soiled cotton load	46
Separate rinsing/spinning	28, 50
Serial number (FN)	14, 16
Silent	37
Siphon	76
Siphon for fabric conditioner	16
Cleaning	55
Skin protection	27, 34
Soap detergent	42
Soap wash	27
Soft water	36
Softener	16, 42
Spare parts	76
Spin speed	29, 33, 71, 77
Spin stop	60
Sprint	25, 47
Standard programmes	17
Stand-by	
Energy-saving	81
Steam anti-crease	26, 47
Stop after rinsing	54
Symbols	6

T

Tears in washing	74
Technical data	77
Technical questions	87
Time	33
Too many articles	64
TouchDisplay	17
Traces of washing detergent in the detergent dispenser drawer ...	66
Type	2

U

Unsatisfactory wash result using detergent for coloureds	73
Unsatisfactory wash result using liquid detergent	73
User settings	32
Exiting	33
Using for the first time	10

V

Validity	2
VAS Vibration Absorbing System	80
Vibrating	65

W	
Warranty extensions	87
Wash results	
Unsatisfactory	72
Washing	
Adding washing detergent	40
Changing selection	51
Drying	67
End of programme	53
Loading	39
Preparing appliance	38
Spinning unsatisfactory	64
Washing detergent	69
Adding	40
Washing feels hard to the touch ..	72
Washing tips	69
Water hardness	41
Water inlet	
Checking	60
Water inlet filter	
Cleaning	56
Water outlet	
Checking	59
Water sounds	65
White residue on washing	72
Whites	19
Whites programme	
Selecting	44

14 Repair service



The «Trouble-shooting» section gives you valuable tips on how to correct minor functions yourself, saving you the time and trouble of calling out a service technician and the cost that goes along with it.

Register your V-ZUG appliance today online via our website at vzug.com or using the card supplied and benefit from the best possible support in the event of a malfunction – including during the manufacturer's warranty period. You need the serial number (FN) and designation of the appliance to register. You can also note them down here or on the service sticker which comes with the appliance:

FN _____ **Appliance** _____

Please have these details to hand when contacting V-ZUG in connection with a malfunction. You will find them on the identification plate of your appliance.

- ▶ Open up drain tray.
 - The identification plate* is located next to the foreign body trap.
- * Depending on the serial number (FN)

Your repair order



You will find contact information for your nearest V-ZUG Service Centre at vzug.com. In most countries you will also be able to contact V-ZUG Service & Support using the toll-free service number 00800 850 850 00 (or +800 850 850 00).

Technical questions, accessories, warranty extensions

Your V-ZUG Service Centre will be happy to help you with any technical questions, to accept your orders for accessories and spare parts and to inform you about the progressive warranty extensions.

Quick instructions

Please first read the safety precautions in the operating instructions!

- ▶ Switch on the appliance and turn on the water tap
- ▶ Open the appliance door by pressing the  or  button
- ▶ Load the washing and then close the appliance door
- ▶ Pull the detergent dispenser drawer out and add the washing detergent
- ▶ Push the detergent dispenser drawer back in
- ▶ Select programme
- ▶ If required, select any additional programme/functions
- ▶ The appliance starts automatically after about 20 seconds

When the programme has finished:

- ▶ Press the  or  button and unload the washing

At the end of the wash day:

- ▶ If necessary, clean the detergent dispenser drawer
- ▶ Push the appliance door to, but do not close

V-ZUG Ltd

Industriestrasse 66, CH-6301 Zug
info@vzug.ch, www.vzug.com

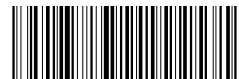

J11006.360-4